

Fairyland



NOTICE OF ASSEMBLE

Tips for assembling

1. Because this product contains small parts, children need to use this product with an adult to avoid accidental ingestion and cause suffocation hazard. There are sharp objects in the product, be careful not to pierce people to avoid injury.
2. After all the materials are used in the required amount in the operation steps, put the remaining materials back into the original bag until the installation is completed. (Avoid losing materials during the installation process)
3. The unit of dimension marked in the step diagram is "cm".
4. Tips for making template paper: Put the template on the back of the material, fix it with some small double-sided tape, and then cut out the material to prevent the cloth or template from moving in the cutting process, or causing errors in the cut material. Or lead to insufficient materials.
5. According to the "Parts Rule Example" at the bottom of this page, refer to the parts on the part number drawing, find the actual product and compare it with the bill of materials, and then install it after confirming that it is correct. (Wooden parts only)
6. It is not advisable to apply too much glue, so as not to wait for a longer time to dry, and overflow will affect the effect of the finished product.
7. There are unavoidable small deviations in the color of wood, fabric, and beads of different batches, without notice, thanks for understanding.

Tips for Assembling Wood



Find the corresponding block number, use a knife in the connection point gently press, you can take out the wood.

Use a knife to smooth out the burr.

Or use sandpaper to smooth out the burr

Testing on LED function

Be sure to test the LED lights before making the lighting, note that the LED white wire to the negative, gray wire to the positive reference to the following figure operation test.

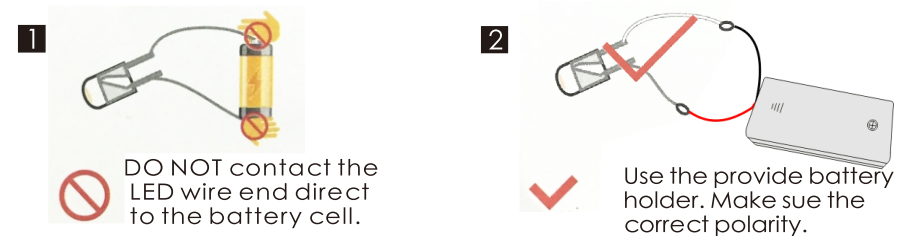

1 DO NOT contact the LED wire end direct to the battery cell.

2 Use the provide battery holder. Make sue the correct polarity.

How to assemble the battery holder

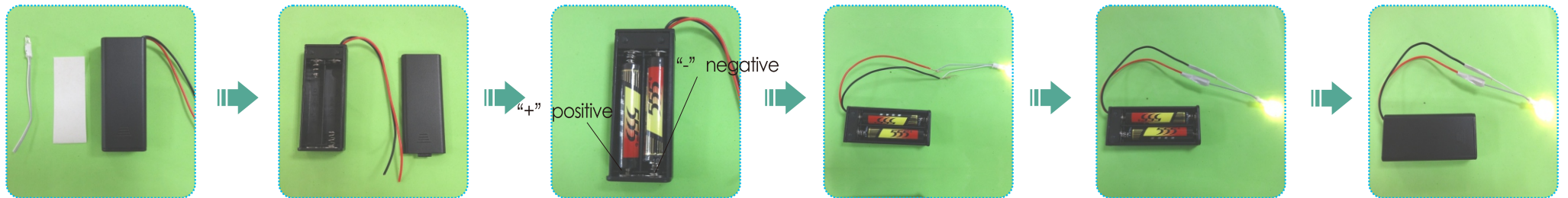

1. Material and tools needed:
- Battery holder, LED bulb, tape, screw driver and 2 pieces AAA size battery(not provided)

2. Use screw driver and take the lid off from the battery holder.

3. Insert the battery take notes on the polarity.

4. Connect the red wire to grey wire, Connect the black wire to white wire.

5. Wrap the exposed wire with the tapes.

6. Place the box lid and fastness with screw driver.

Examples of parts rule:

A01: The parts are directly in the box; B01: The parts are in the B bag; C01: The parts are in the C bag, and so on. (Note: The printing paper A26 is displayed in the step, and the part number is A26-1; In the step, the template paper A27-M01 is displayed, A27 is the template paper, M01 is the cutting template used for the corresponding material, M01-1, M01-2 are the part numbers for the parts, the printing paper and the template paper are directly placed in the box)

Catalogue

Accessory name	Related Materials Bag
Printing Paper	A26、A27 in Bag A (all of Printing paper and Template are in A26、A27, total 2 sheets of A3 Printing paper, 3 sheet of A3+1 sheet of A4)
Small bridge+ Wind and rain pavilion	Bag A+Bag E+Bag Q+Printing paper+Template Page 3-4
Waterwheel	Bag F Page 4-5
Gaily painted pleasure boat	Bag A+Bag F+Bag Q+Template Page 5
Pendant lamp 1,2,3+Floor lamp	Bag G + Bag N+Bag Q+Printing paper+Template Page 6
Table chair+lounge chair	Bag G+Bag H +Bag K+Bag M +Printing paper+Template Page 7-8
Plant+bench +tea table+chair	Bag H+Bag M+Printing paper+Template Page 8-9
Side table 1,2+mirror +bathroom cabinet	Bag J+Bag M+Bag N+Printing paper+Template Page 9-10
Bath+fan+bed	Bag J+Bag K+Bag M+Bag N+Printing paper Page 10-11
Bedside cupboard + floor lamp+zither	Bag K+Bag M+Printing paper Page 11
Bookcase+desk +chair+side table 3	Bag L+Bag M+Printing paper Page 12-13
Step 1,2+stone lion +lantern+stair	Bag D+Bag M+Bag N+Template Page 13
Large roof	Bag A+Bag C+Template Page 14
Small roof+side roof	Bag A+Bag D+Template Page 14-15
Waterfall+Step 3	Bag A+Bag E+Bag L+Template Page 16
Library	Bag A+Bag B+ Bag E+Printing paper+Template Page 17-18
Upgraded accessories	Bag P Page 18
Base	Bag A+Bag B+Bag C+Bag P+Printing paper Page 18-23
House	Bag A+Bag B+Bag C+Bag K+Printing paper Page 23-27
Splicing of outer frame	Bag A+Bag B+Bag K+Printing paper Page 27-29
Installation of battery box	Bag Q Page 29
Production of dust cover	Bag Q+Bag Z Page 30

Thumbnail of material list (reference only)



Thumbnail of printing paper & template paper (reference only)



Symbol description used

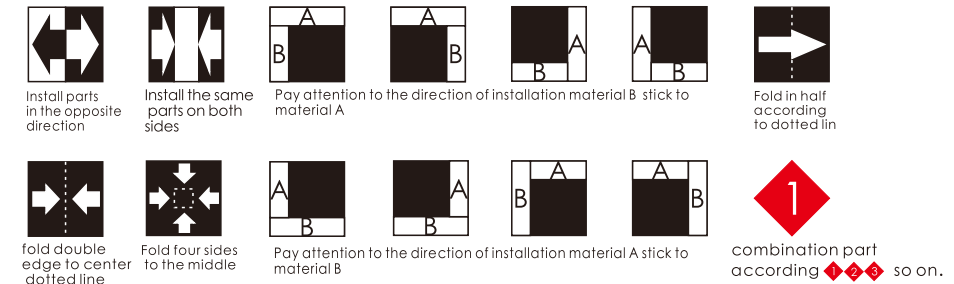

About the use of glue

Method for using glue:

1. After applying the glue, let it dry for a few seconds before pasting.
2. Fix it slightly with your hands, and finally put it aside to dry;

Tips:

When pasting the plane printing paper, a piece of waste bank card or telephone card can be used to wipe evenly after the glue is smeared on the wood board, and then the printing paper is pasted to squeeze out the air inside.

Types of glue:

White latex: Used for adhering soft materials, such as wood and paper.
 Alcoholic Glue: Used for adhering hard materials such as cloth, plastic, beads, wire, dust cover, etc.

Small bridge

Before making, please cut out E03

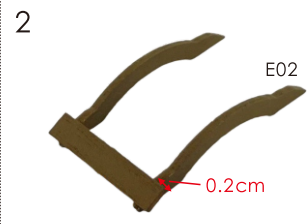
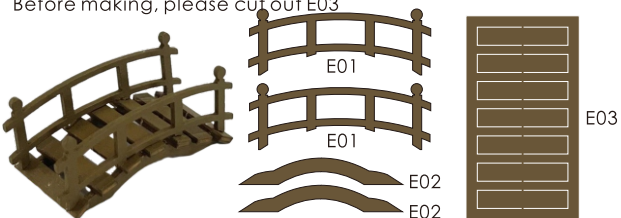

wind and rain pavilion

Before making, cut out A19-1, A20-2 and E19, and cut out A21 according to the template

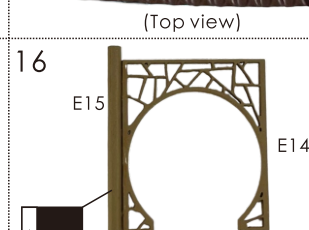
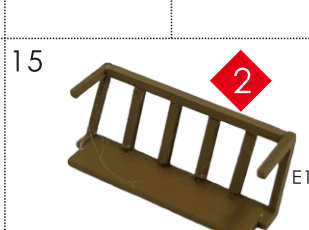
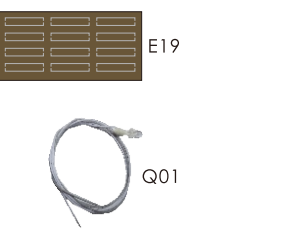
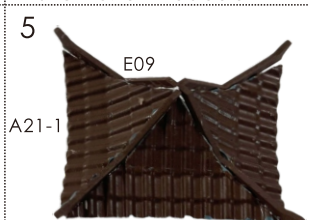
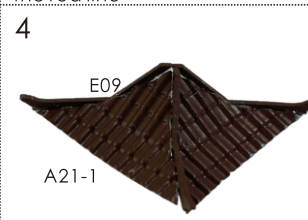
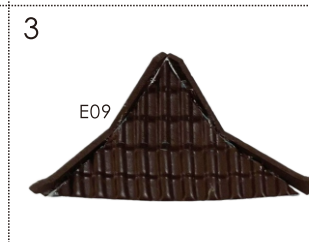
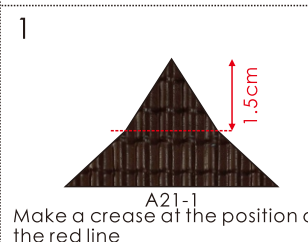
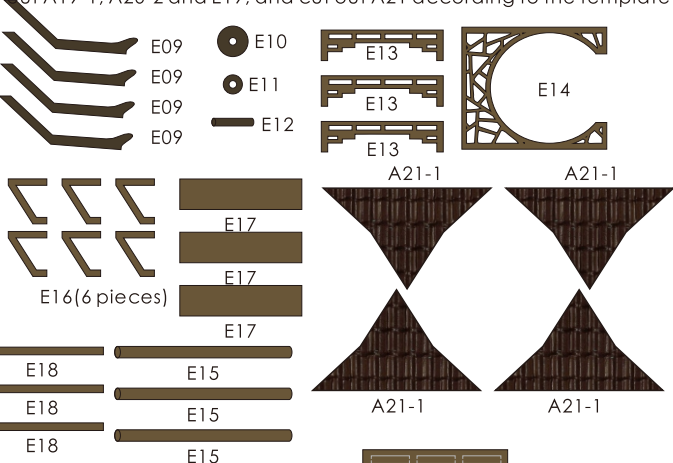

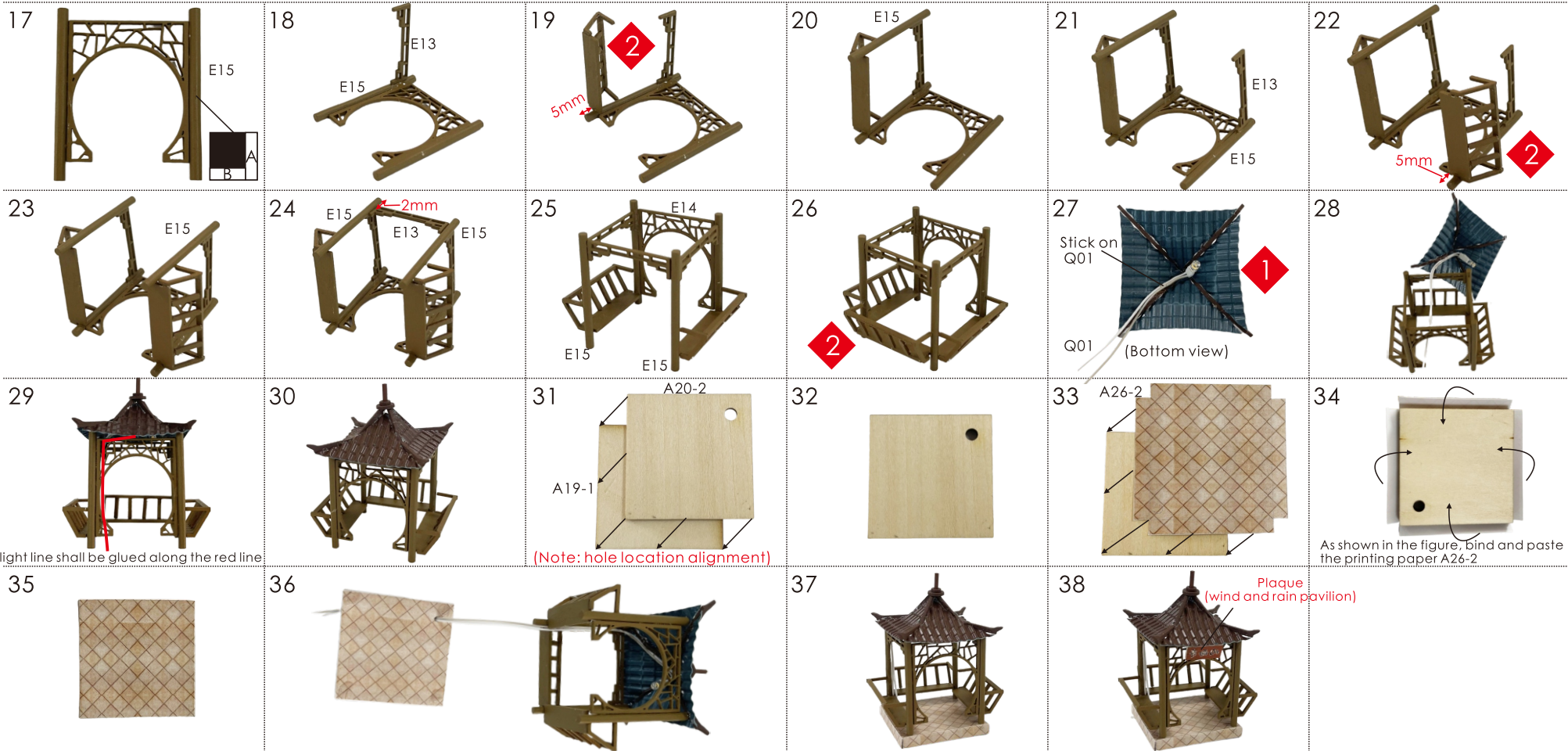

The light line shall be glued along the red line

(Note: hole location alignment)

As shown in the figure, bind and paste the printing paper A26-2

Plaque (wind and rain pavilion)

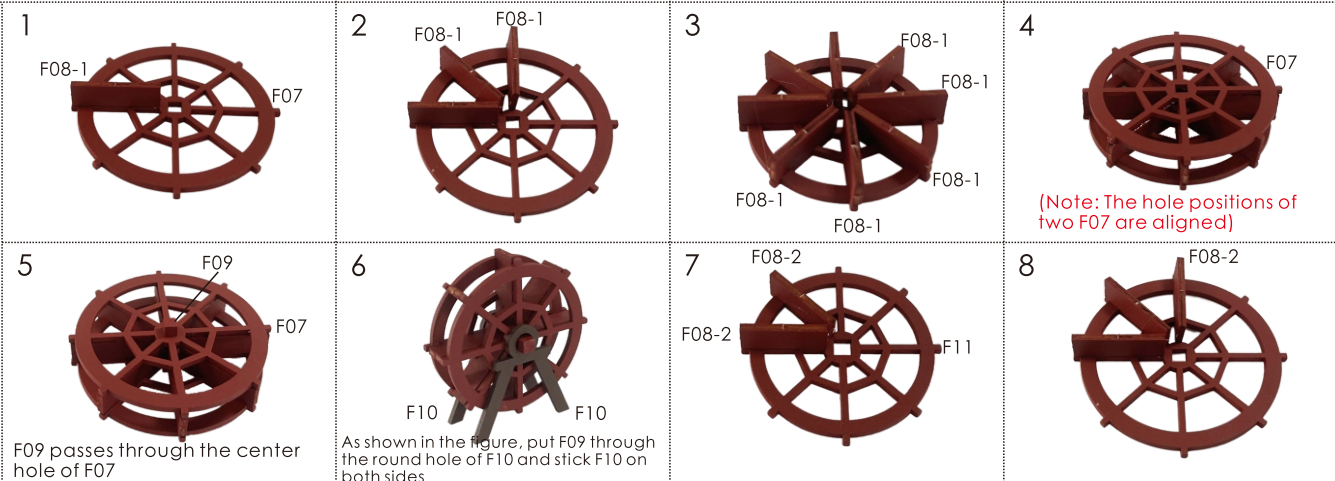
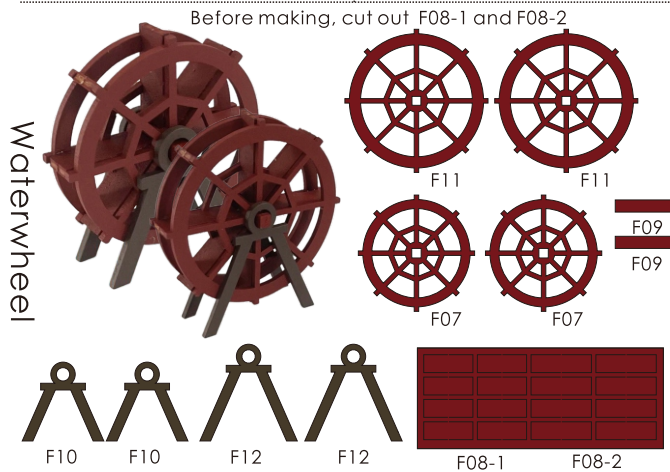

(Note: The hole positions of two F07 are aligned)

F09 passes through the center hole of F07

As shown in the figure, put F09 through the round hole of F10 and stick F10 on both sides.

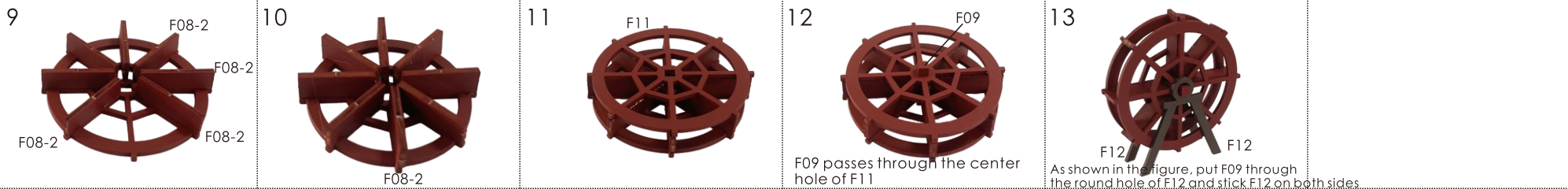

Gaily painted pleasure boat

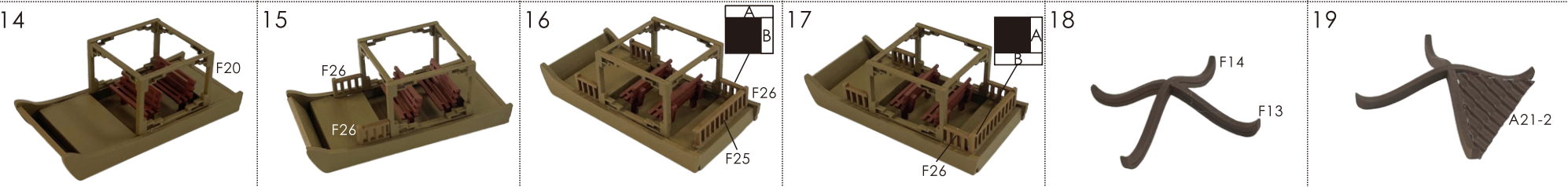
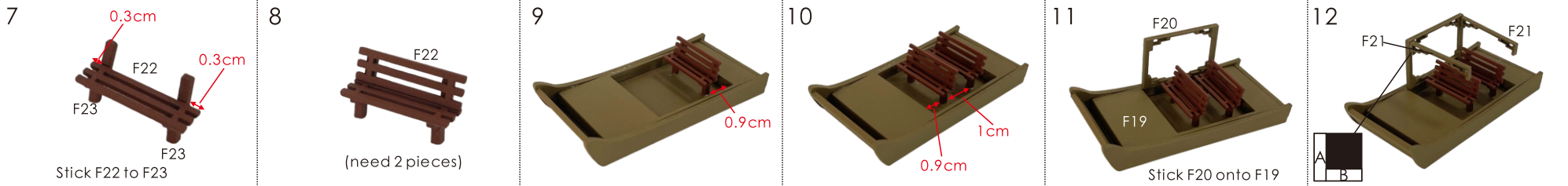
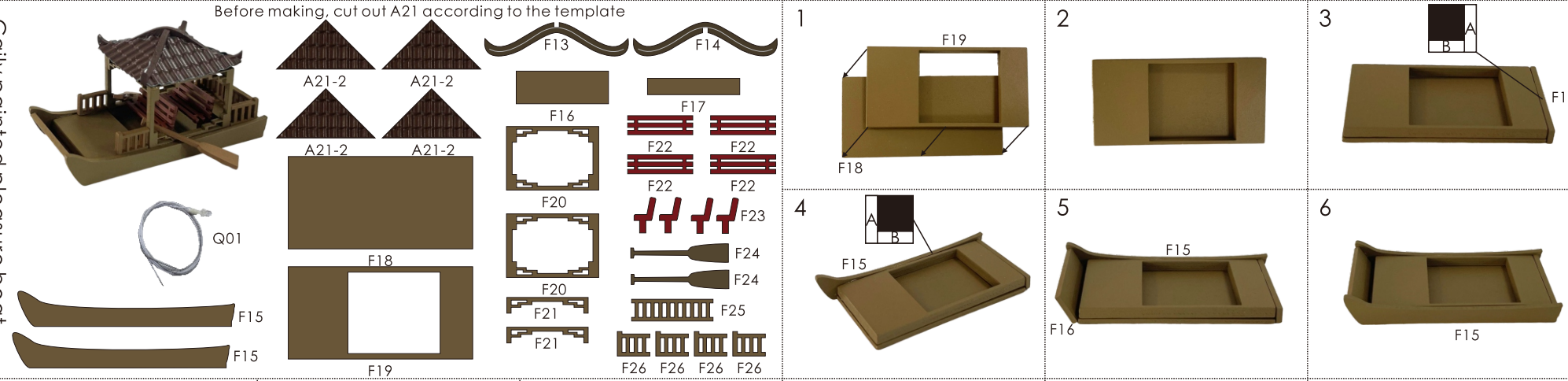

Pendant lamp 1

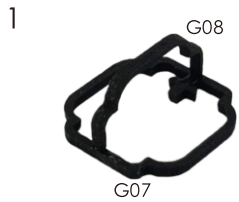
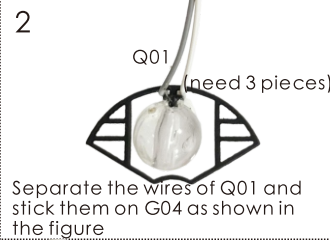
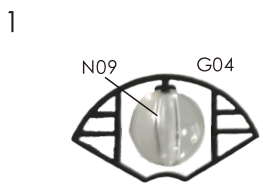
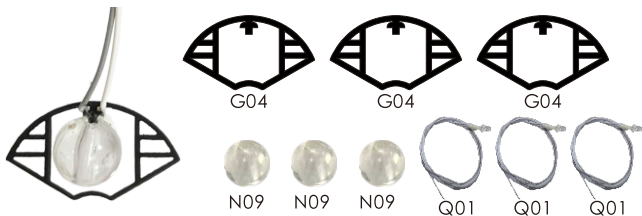

Pendant lamp 3

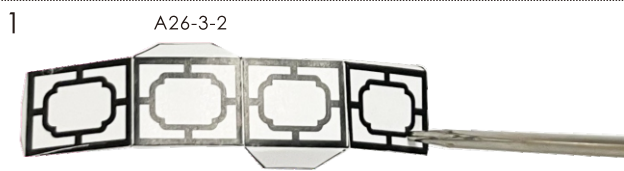
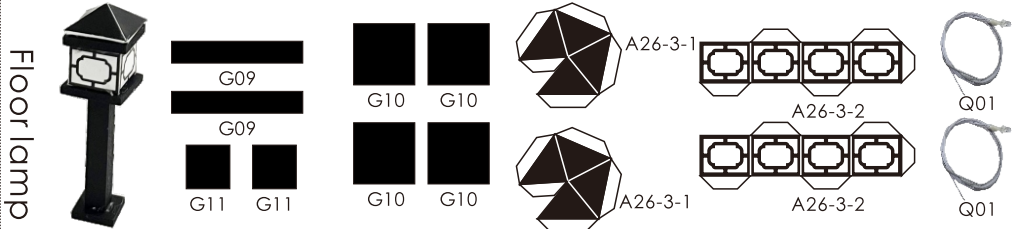
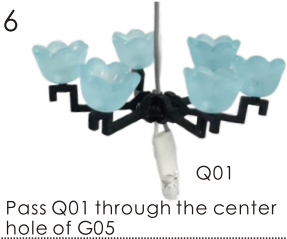
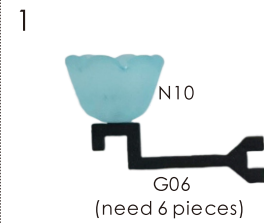
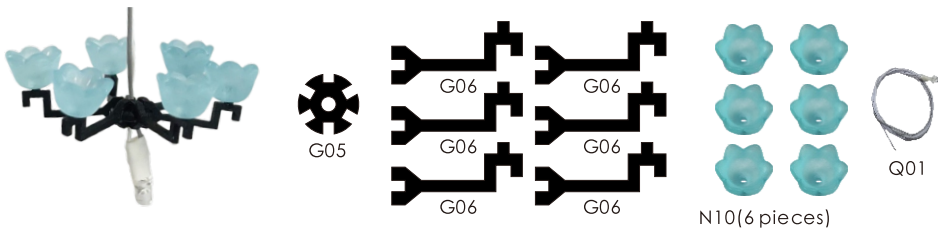

Punch a small hole at the position on the drawing

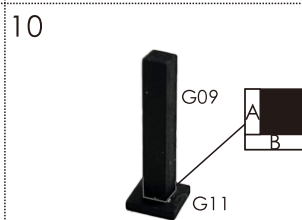
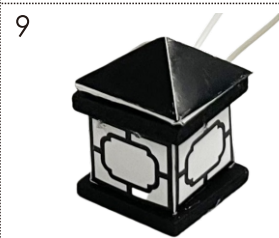
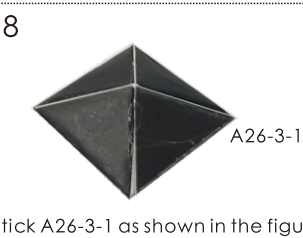
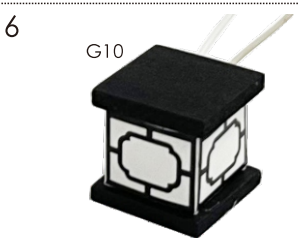
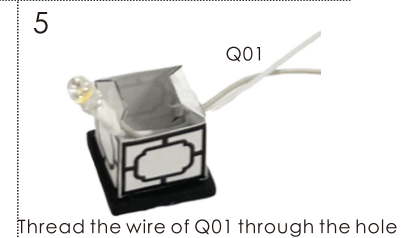
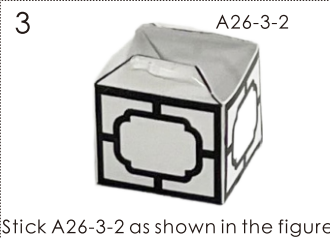
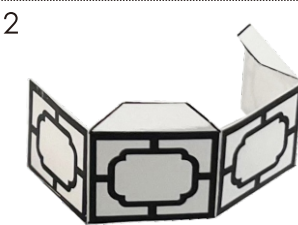
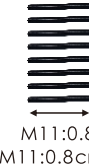
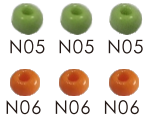
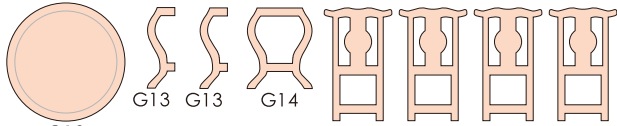

Table chair



Before making, cut M05 out according to the template



M11:0.8cm
M11:0.8cm
*8pieces

1	 M05-1 G15	2	 G16 G15	3	 G18 G15
4	 G17 G16	5	 G17 G16 (need 4 pieces)	6	 G14 G12 (back)
7	 G13 G12	8	 G13 G12	9	 G12 (positive)
10	 N07 N11	11	 N13 N11	12	 N05 N06
13	 N06 G12	14	 N04 N11 (need 4 pieces)	15	 N04 N11 (need 4 pieces)
16	 N04 N11 (need 4 pieces)	17	 N04 N11 (need 4 pieces)		

Lounge chair

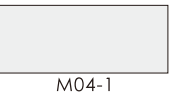
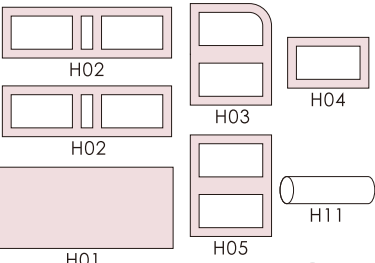

1	 H02 H01	2	 H02 H01	3	 H04 H01	4	 H05 H01
5	 H03 H01	6	 M01-1 M04-1 Wrap M04	7	 M01-1 M04-1	8	 M01-1 M04-1

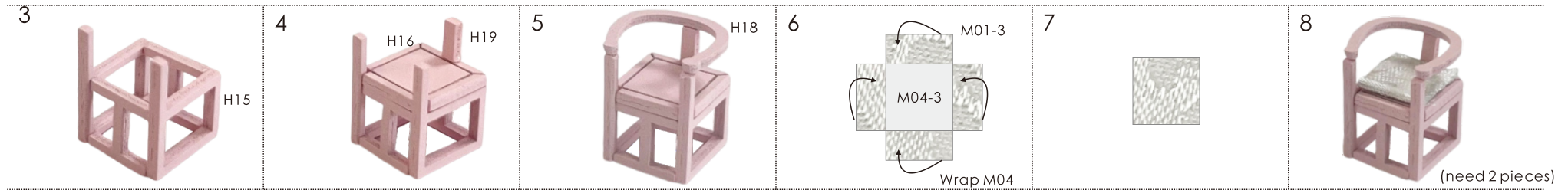

Side table 1

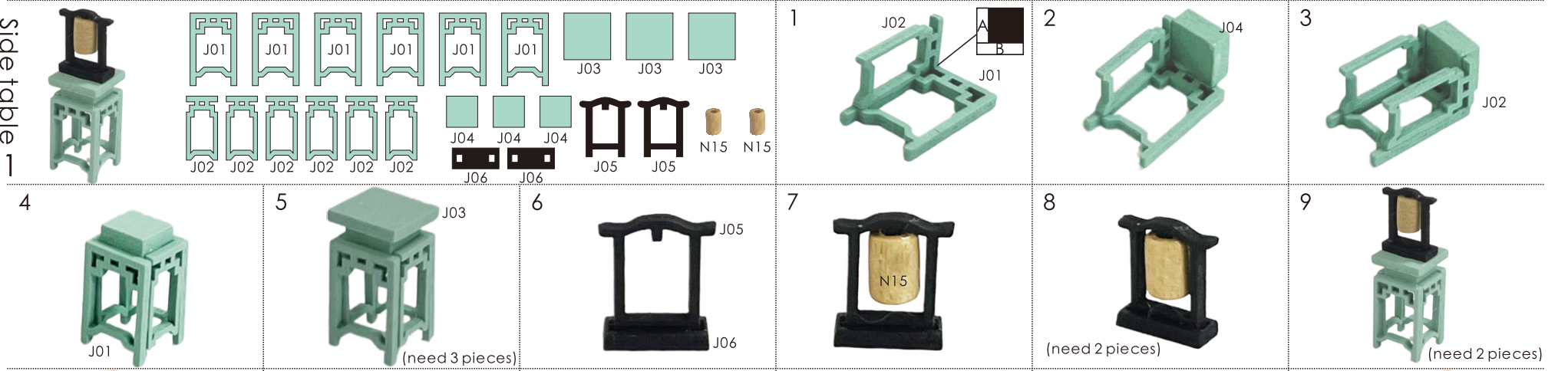

Side table 2

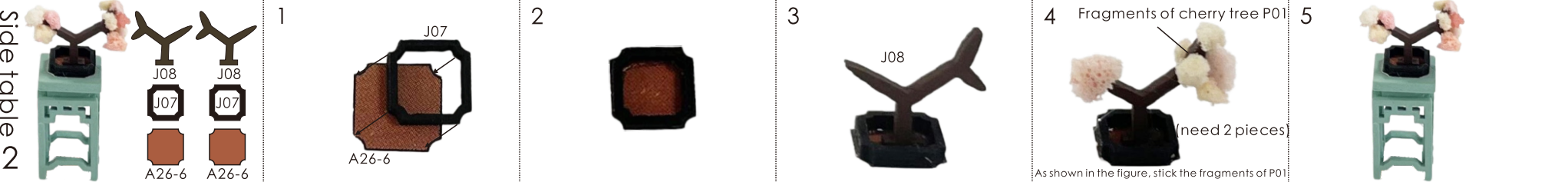

Mirror

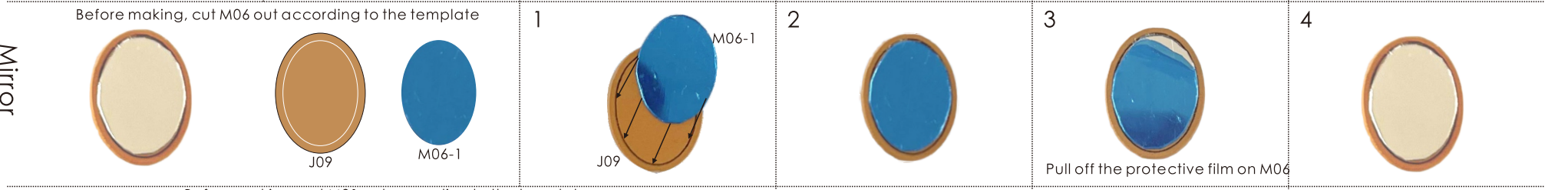

Bathroom cabinet

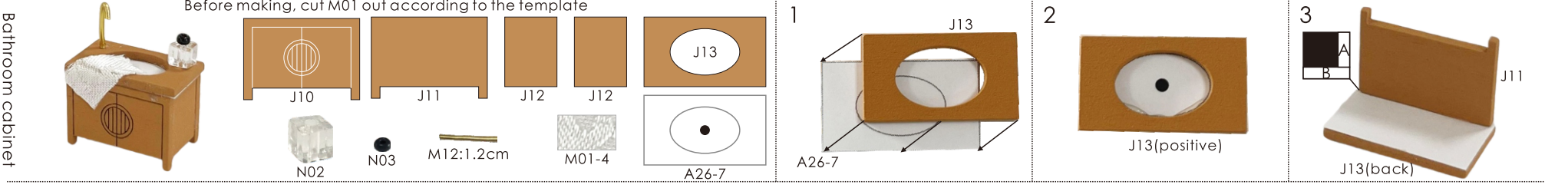

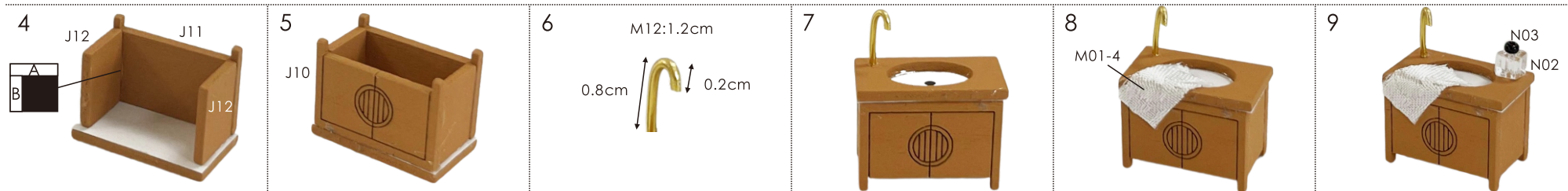

Bath

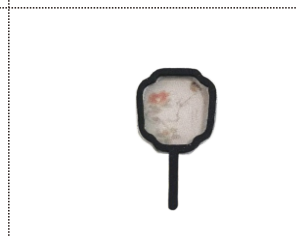
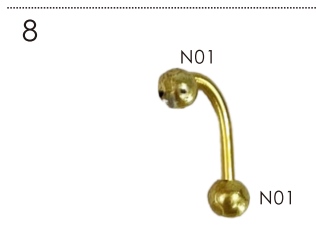
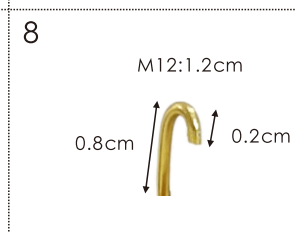
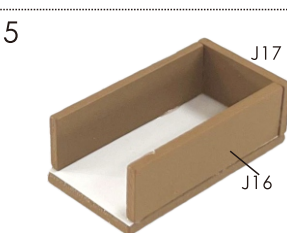
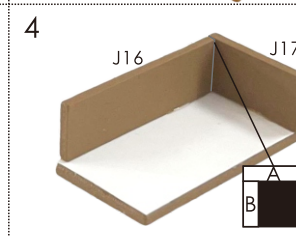
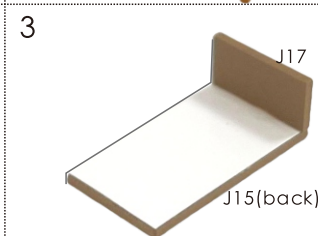
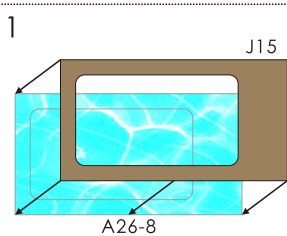
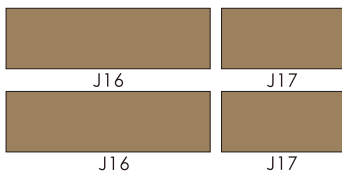
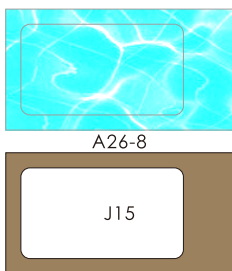

Fan

Before making, cut M01, M02, M04 and M05 according to the template

Bed

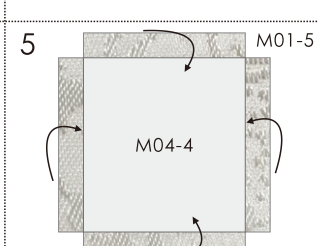
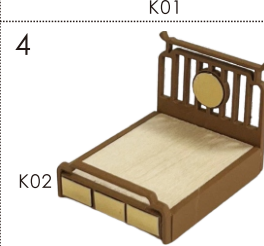
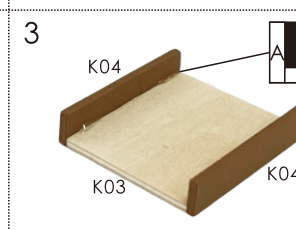
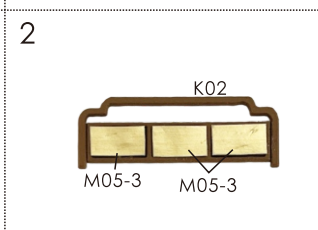
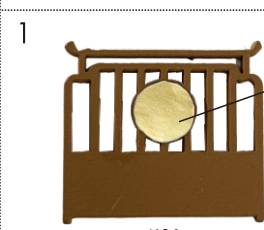
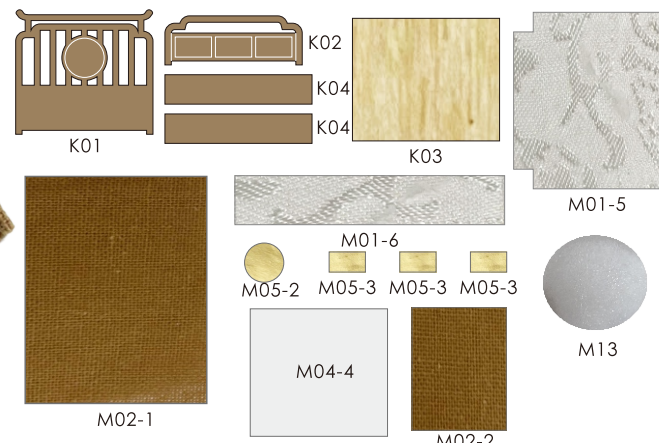

Wrap M04 with cloth M01

<p>7</p> 	<p>8</p>  <p>5cm</p> <p>M02-1</p>	<p>9</p>  <p>M13</p> <p>After folding in half, put an appropriate amount of cotton in the gap</p>	<p>10</p>  <p>M02-1</p> <p>Seal the gap with glue</p>	<p>11</p>  <p>0.5cm</p> <p>5cm</p> <p>0.5cm</p> <p>Fold back 0.5cm</p>	<p>12</p>  <p>0.5cm</p> <p>Fold back 0.5cm</p>						
<p>13</p>  <p>M02-2</p> <p>2.6cm</p> <p>Glue the red line and fold it in half</p>	<p>14</p>  <p>M02-2</p> <p>1.3cm 1.3cm</p> <p>Cut M02-2 according to the position of the red line</p>	<p>15</p>  <p>Seal one side of the mouth with glue</p>	<p>16</p>  <p>M13</p> <p>After folding in half, put an appropriate amount of cotton in the gap</p>	<p>17</p>  <p>(need 2 pieces)</p> <p>Seal the gap with glue</p>	<p>18</p>  <p>Fan</p> <p>M01-6</p> <p>Put the quilt and pillow on the bed</p>						
<p>Bedside cupboard</p> 	 <p>K05 K06 K08</p> <p>K07 K07 K09</p>	<p>1</p>  <p>A B</p>  <p>K07 K07</p> <p>K06</p> <p>(Note: The side with the picture of K06 faces outward)</p>	<p>2</p>  <p>K08</p> <p>K07</p>	<p>3</p>  <p>K05</p> <p>K06</p>	<p>4</p>  <p>K09</p>						
<p>Floor lamp</p> 	<p>Before making, pull out K12-1 and K12-2</p>  <p>K10 K11</p> <p>K12-1 K12-2</p> <p>A26-10-1</p>	<p>1</p>  <p>K12-1 A26-10-1</p> <p>K12-2</p> <p>Paste around as shown in the figure</p>	<p>2</p> 	<p>3</p>  <p>K10</p> <p>K11</p>	<p>4</p> 						
<p>Zither</p> 	 <p>K15</p> <p>A26-10-2</p> <p>M11:0.8cm*2 pieces</p>	<table border="1"> <tr><td>M10:1.8cm</td></tr> <tr><td>M10:1.9cm</td></tr> <tr><td>M10:2cm</td></tr> <tr><td>M10:2.1cm</td></tr> <tr><td>M10:2.2cm</td></tr> <tr><td>M10:2.3cm</td></tr> </table>	M10:1.8cm	M10:1.9cm	M10:2cm	M10:2.1cm	M10:2.2cm	M10:2.3cm	<p>1</p>  <p>A26-10-2</p> <p>K15</p>	<p>2</p>  <p>K15(positive)</p>	<p>3</p>  <p>M11:0.8cm M11:0.8cm</p> <p>Bend the wire into the shape shown in the figure</p>
M10:1.8cm											
M10:1.9cm											
M10:2cm											
M10:2.1cm											
M10:2.2cm											
M10:2.3cm											
<p>4</p>  <p>M11:0.8cm M11:0.8cm</p>	<p>5</p>  <p>M10:1.9cm M10:1.8cm</p> <p>Stick M10 as shown in the figure</p>	<p>6</p>  <p>M10:2cm M10:2.1cm</p> <p>M10:2.2cm M10:2.3cm</p>	<p>7</p>  <p>K16 K16</p> <p>0.5cm</p> <p>K15(back)</p>	<p>8</p> 							

Bookcase

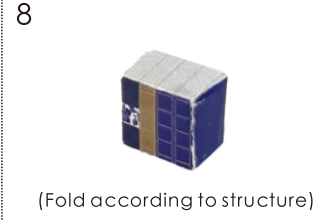
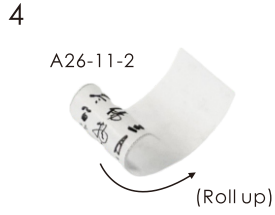
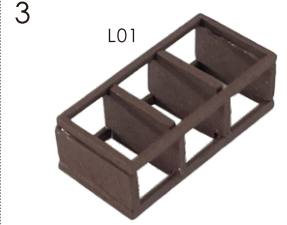
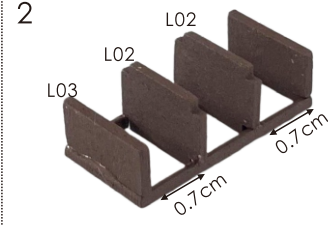
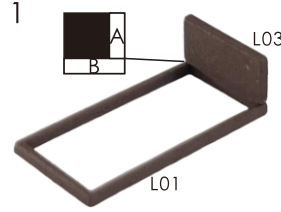
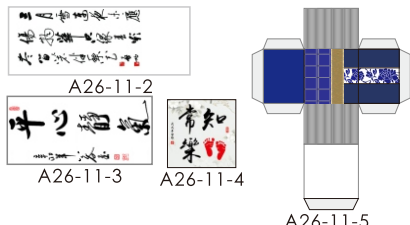
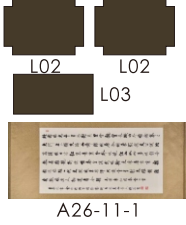
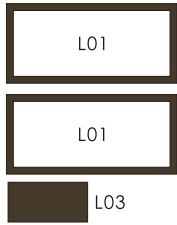

Desk

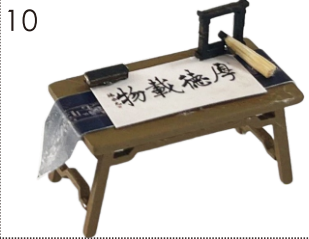
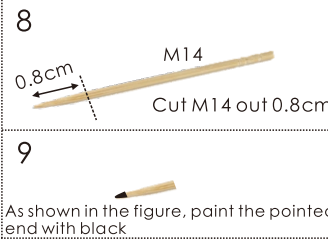
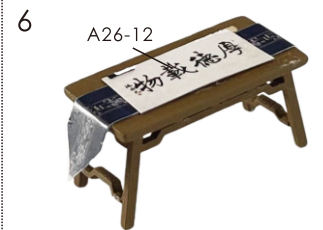
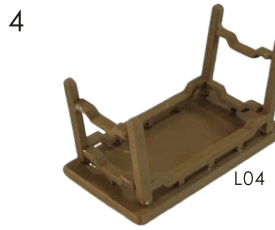
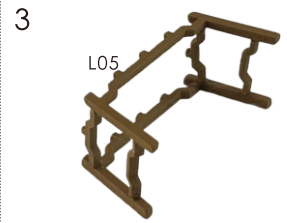
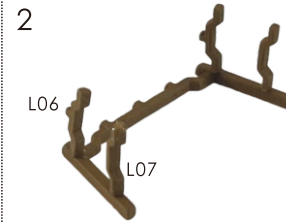
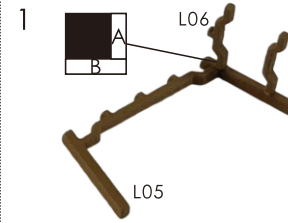
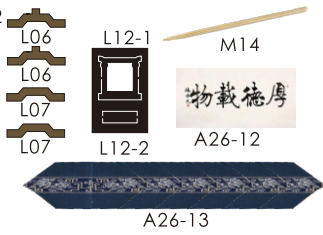
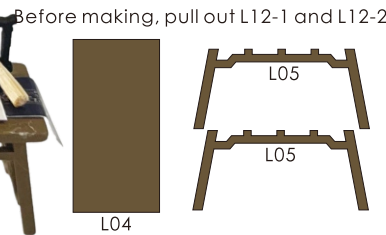

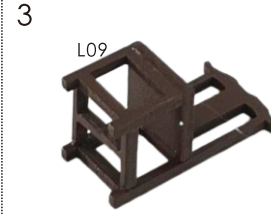
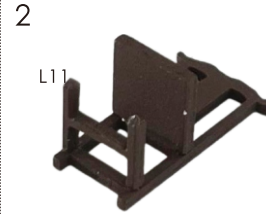
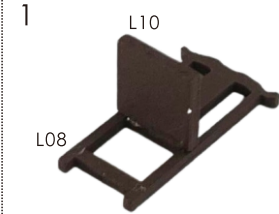
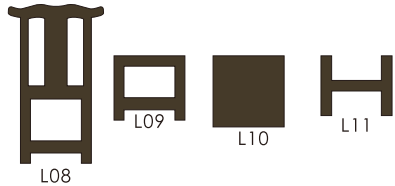

Chair

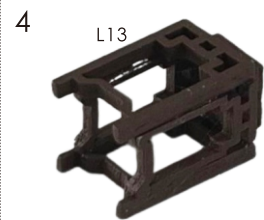
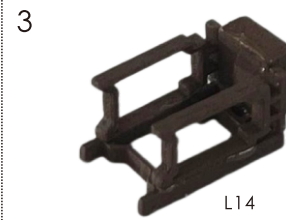
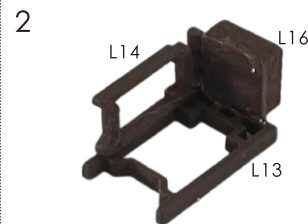
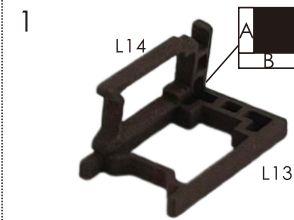
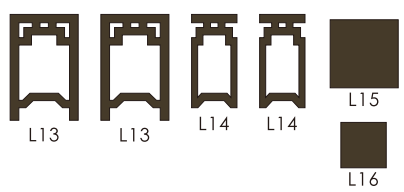

Side table 3



5  6  L15

Before production, cut out D13 and M03 according to Template

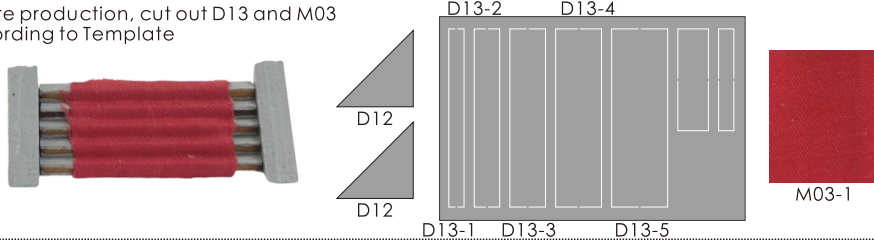
Step 1 

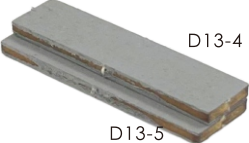
1  D13-4
D13-5
(Note: Align to the right)

2  D13-3

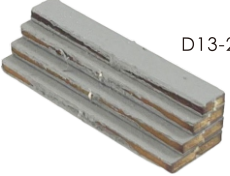
3  D13-2

4  D13-1

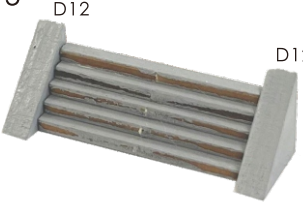
5  D12

6  M03-1

7 

Before making, cut out D13 and M03 according to Template

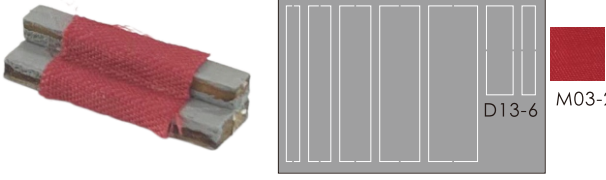
Step 2 

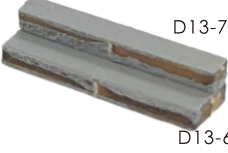
1  D13-7
D13-6
(Note: Align to the right)

2  M03-2

3 

4 

Stone lion 

 P08 P09

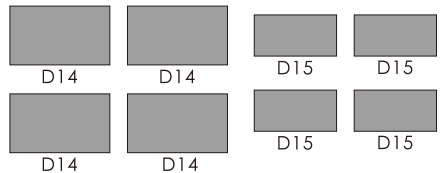
 D14 D14 D15 D15

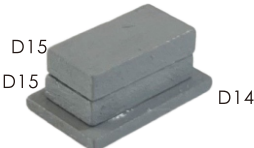
1  D14
D15 D15

2  D14
(need 2 pieces)

3  P08 P09

Lantern 

 N14(8 pieces)
N01(16 pieces)

 M09:3.5cm*8pieces

1  N12
0.8cm
Tie a knot at the position on the figure

2  N01

3  N12

4  N14

5  N12

6  N01
(need 8 pieces)

stair 

Before making, please cut out G02

 G01 G02-1 G02-2

1  G01

2  G02-1 G02-1 G02-1

3  G02-2 G02-2

Small roof

Before production, cut out A19-2-2 and A21 according to Template

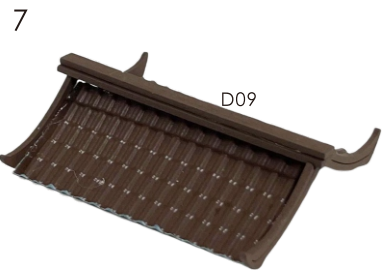
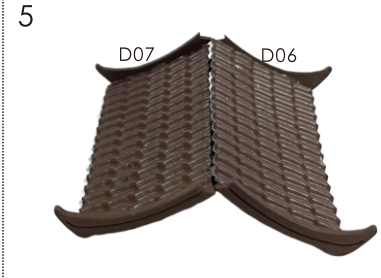
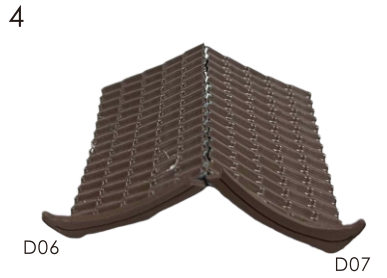
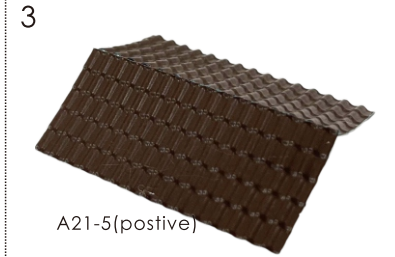
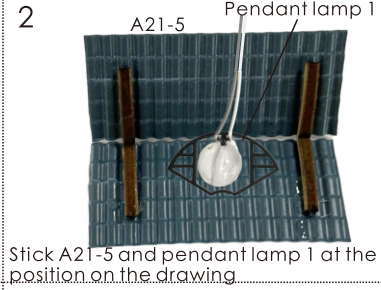
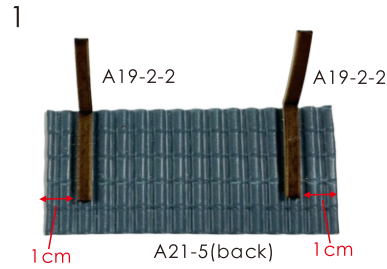
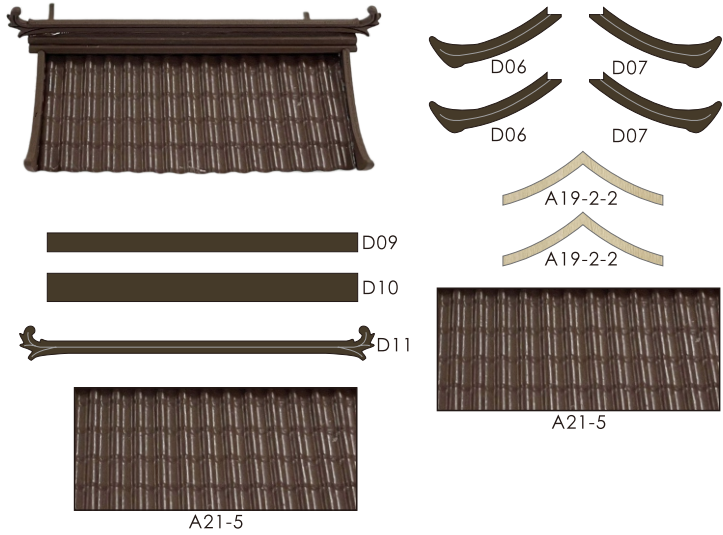

Side roof

Before making, cut out A19-2-2 and A21 according to Template

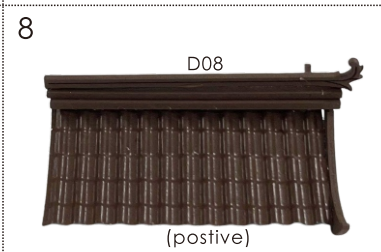
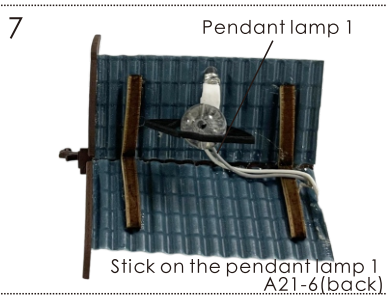
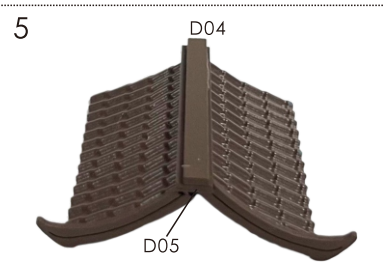
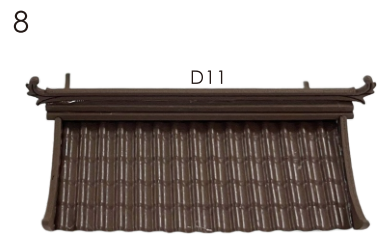
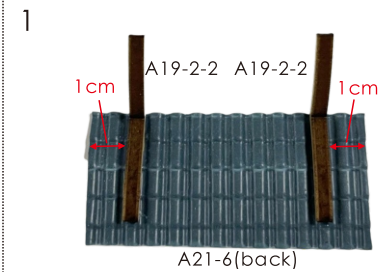
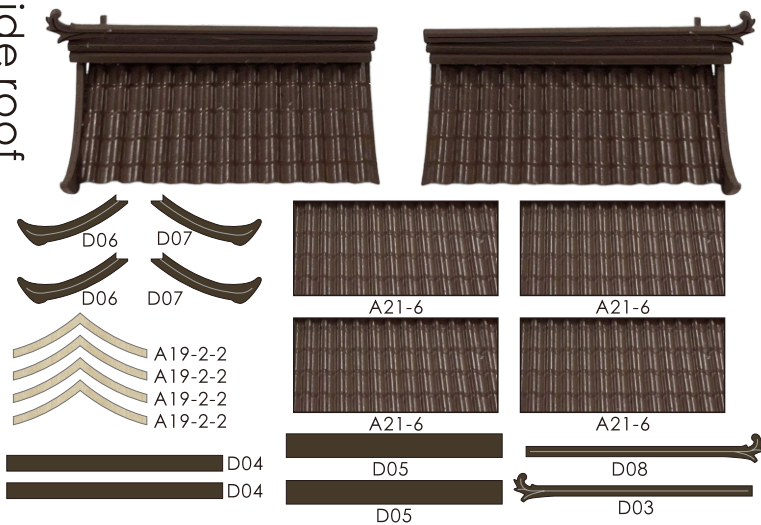

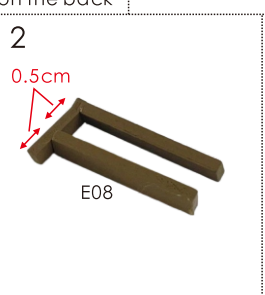
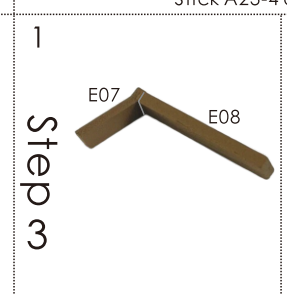
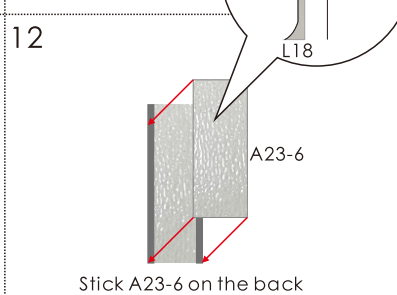
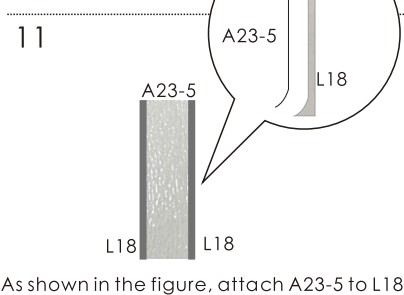
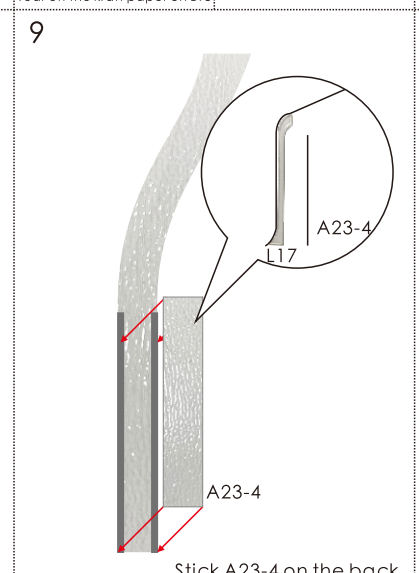
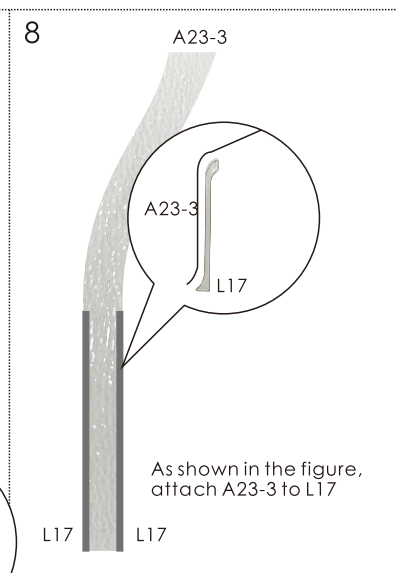
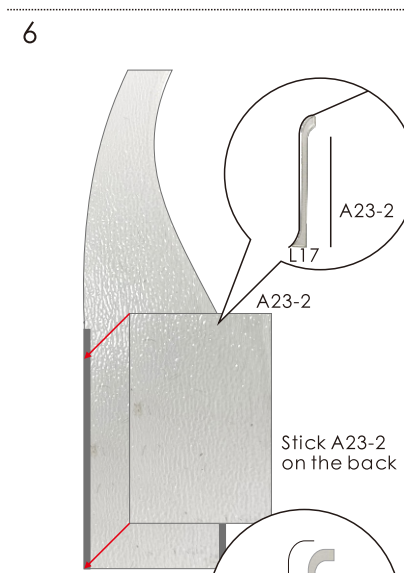
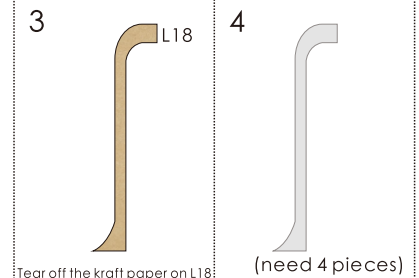
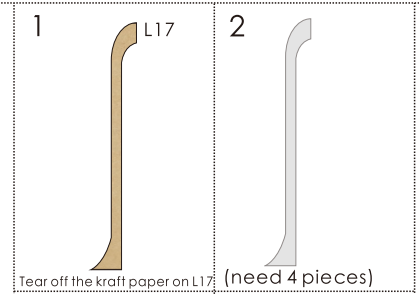
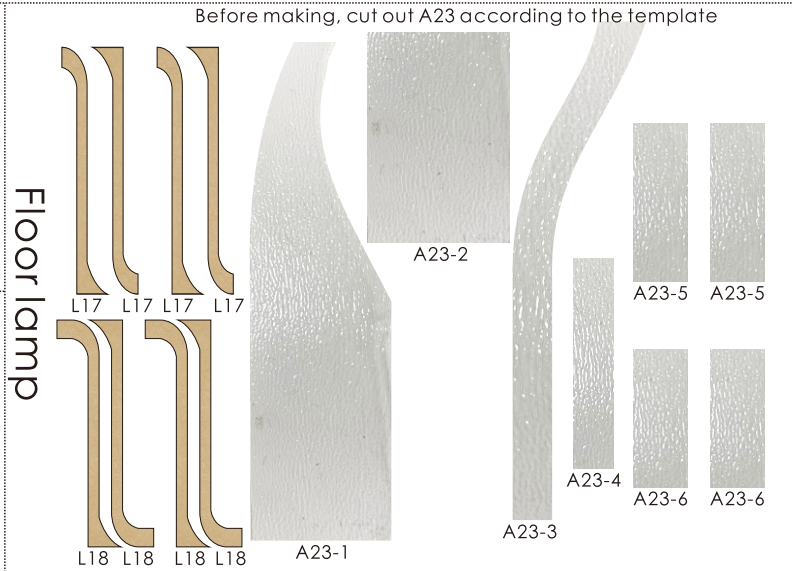
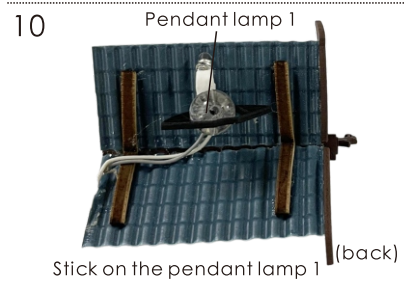

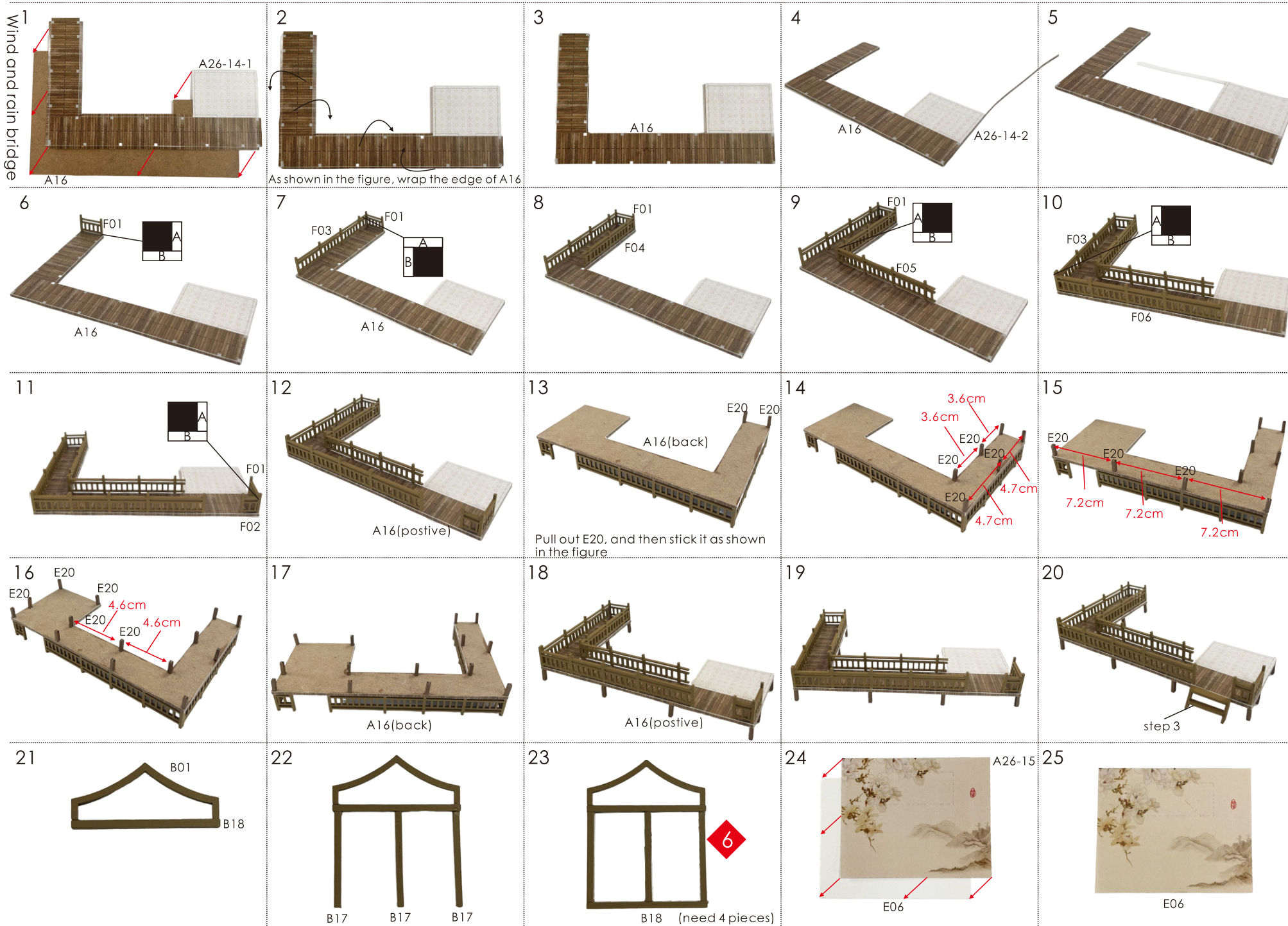

26  A26-16
Stick A26-16 on the wire frame of A26-15

27  6

28  E06

29  Book case

30  Side table 3

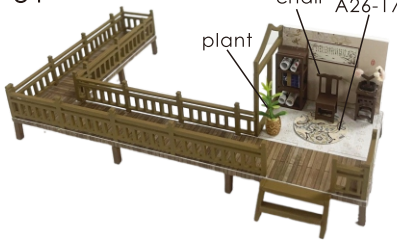
31  chair A26-17
plant

32  desk

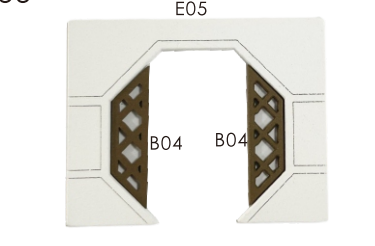
33  E05
B04 B04

34  E05

35  6

36  Small roof

37  Plaque (Library)

38  lantern

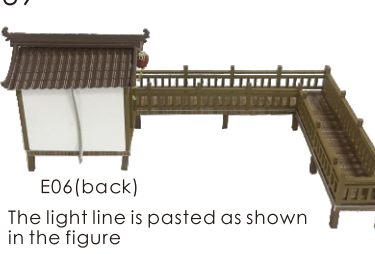
39  E06(back)
The light line is pasted as shown in the figure

**Upgraded Accessories
(Need To Purchase Separately)**

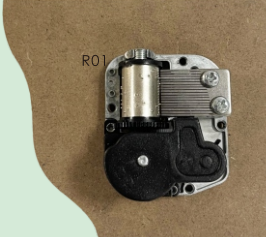
1  R01
Clockwork Movement (1 piece)

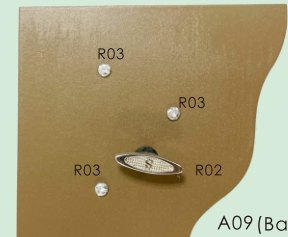
2  R02
Movement Handle (1 piece)

3  R03
Movement Screws (3 pieces)

4  A10

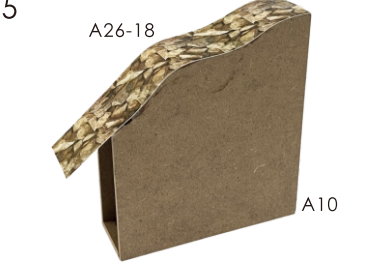
5  A26-18
A10

6  A10

7  A09 (back)

8  A08
7
(positive)



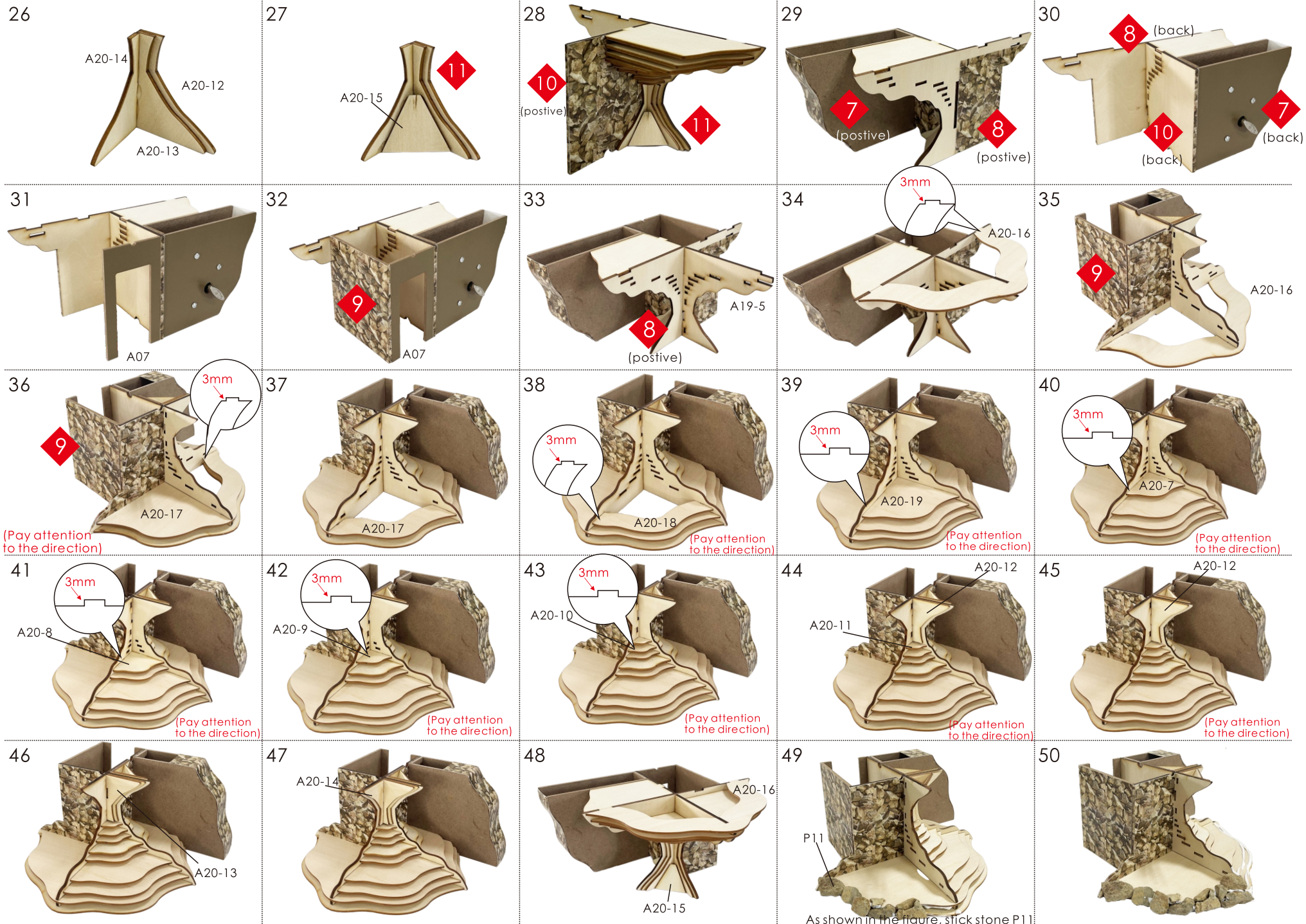

26

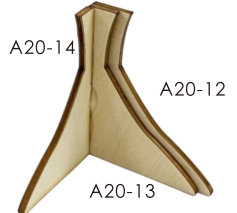

27

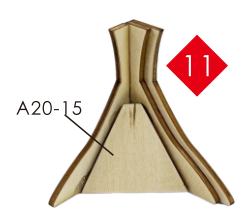

28



29



30



31

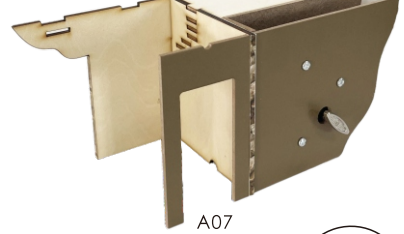

32



33



34

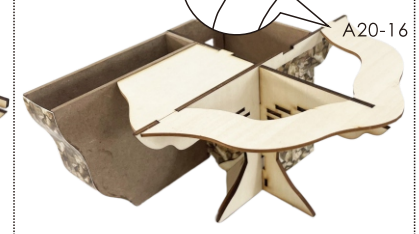

35



36



37



38

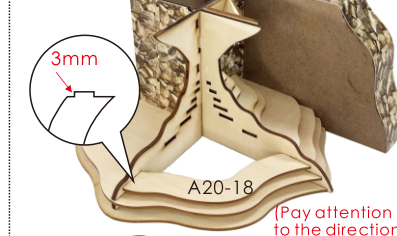

39

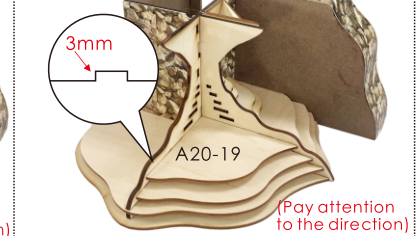

40

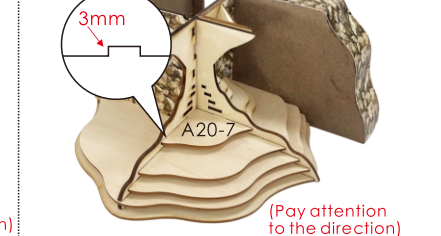

41

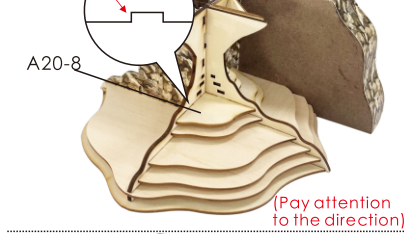

42



43



44

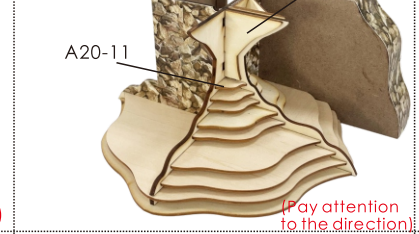

45



46

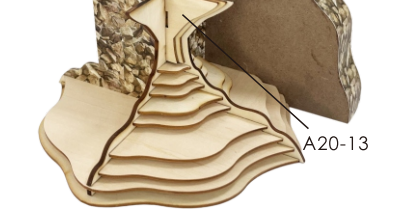

47

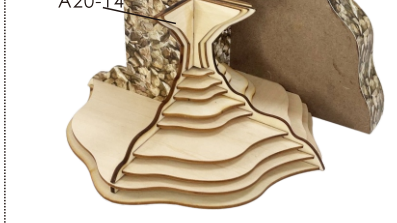

48



49



50



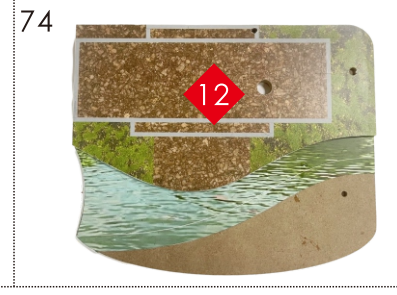
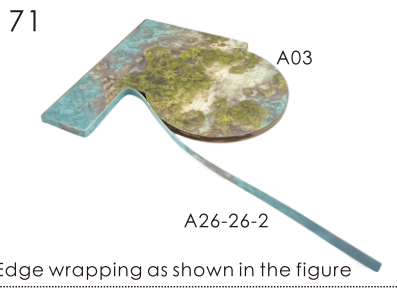
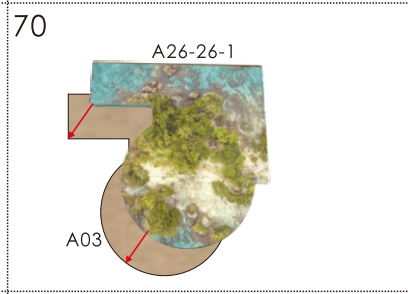
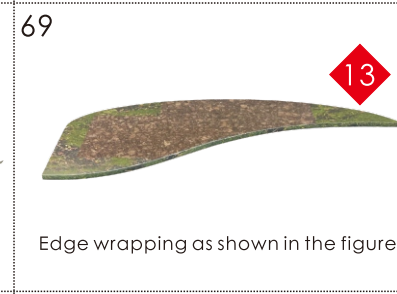
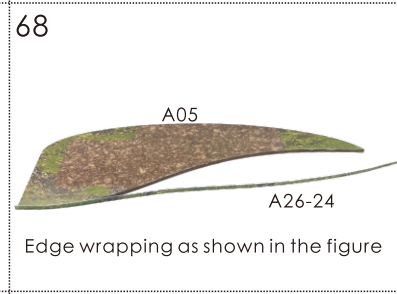
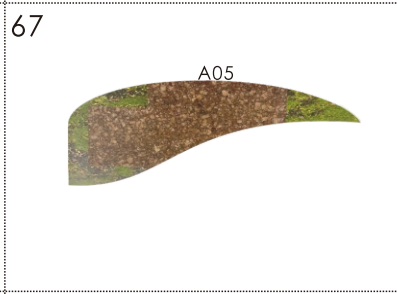
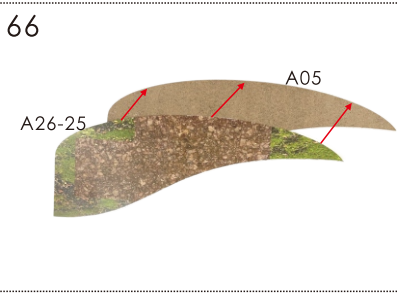
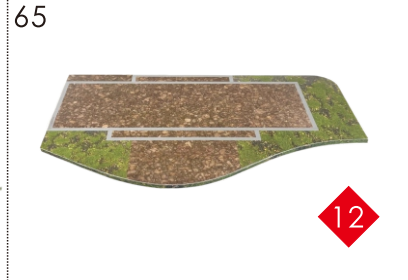
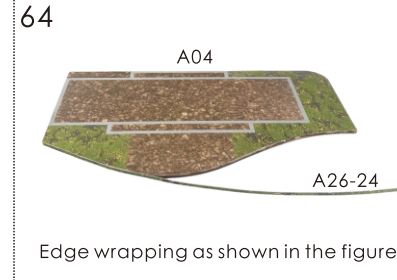
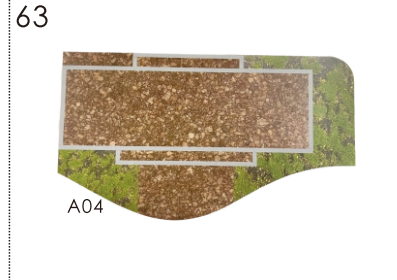
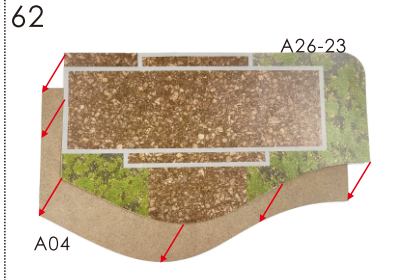
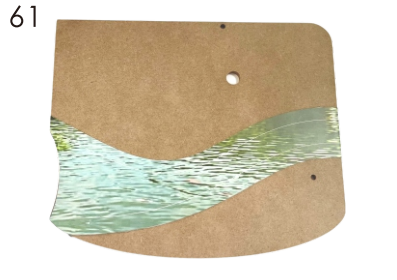
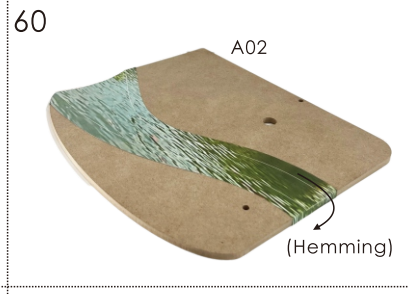
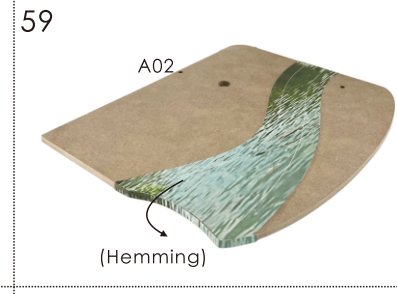
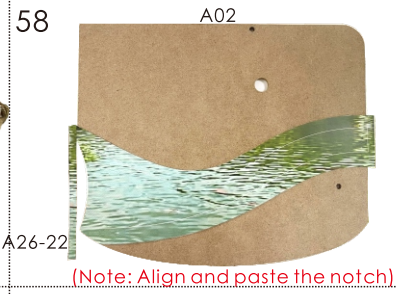
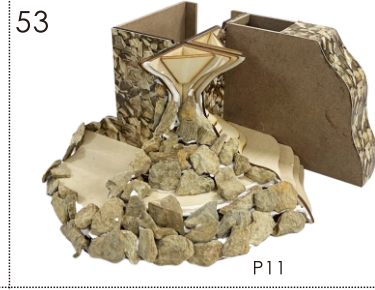
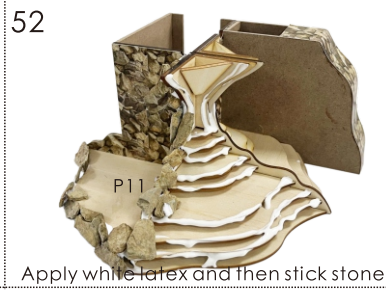

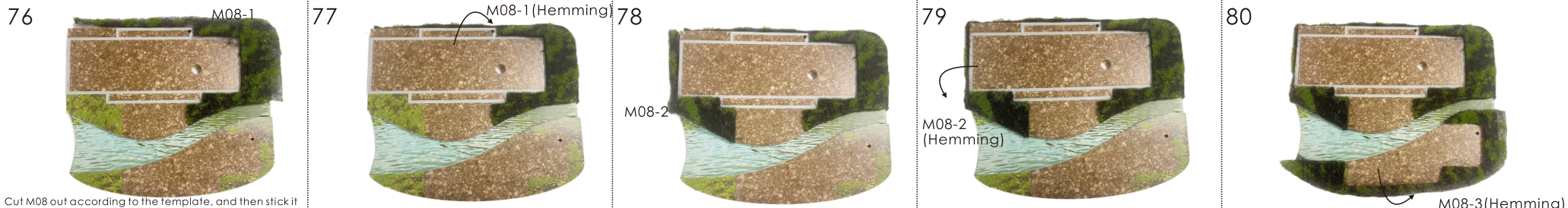

Cut M08 out according to the template, and then stick it as shown in the figure (Note: Template needs to be pasted on the back of M08)

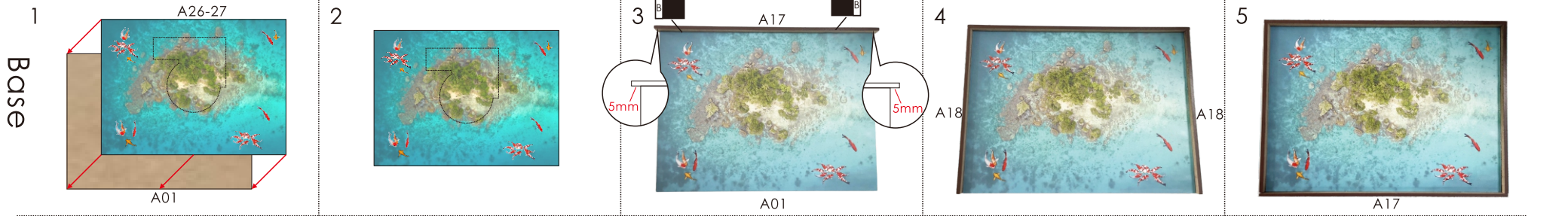
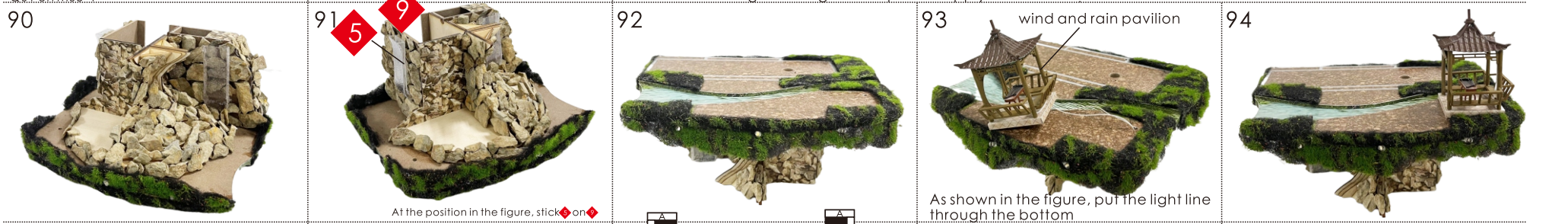
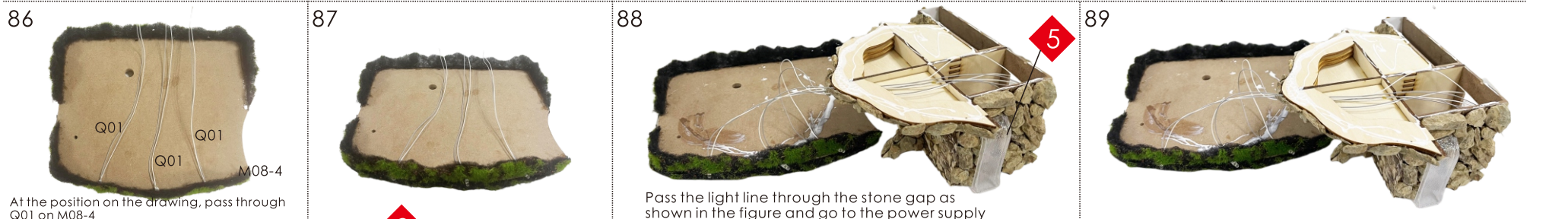
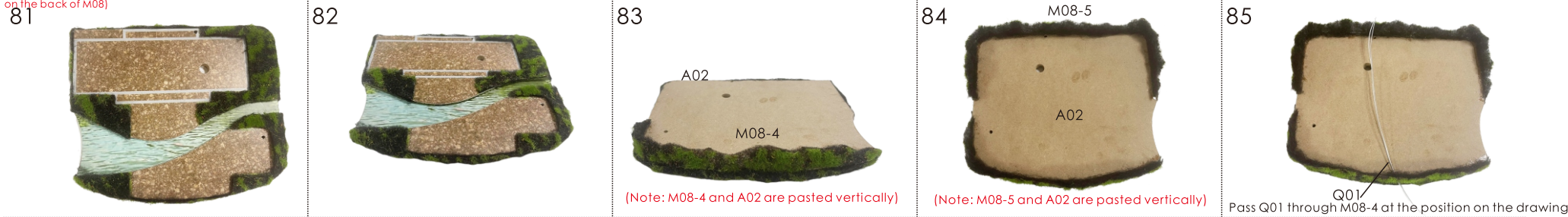

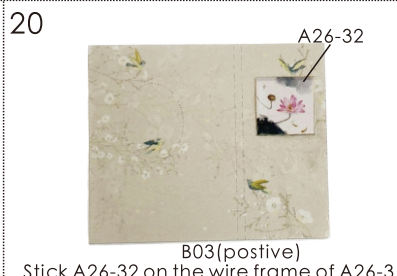
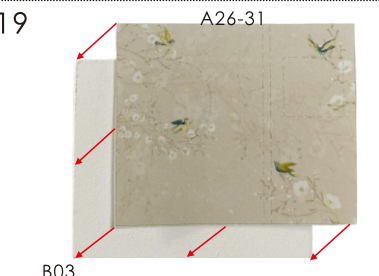
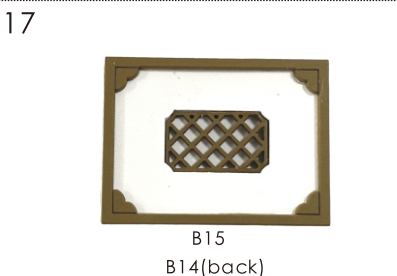
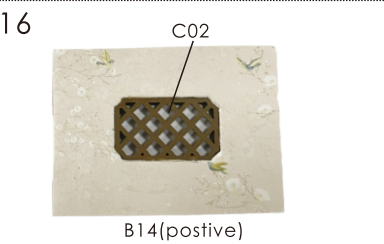
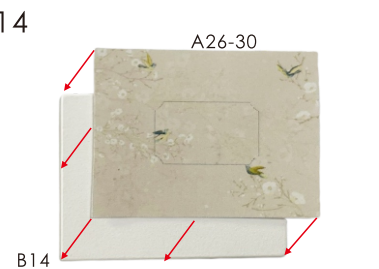
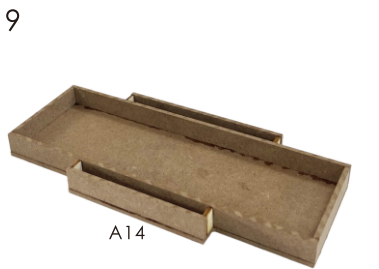
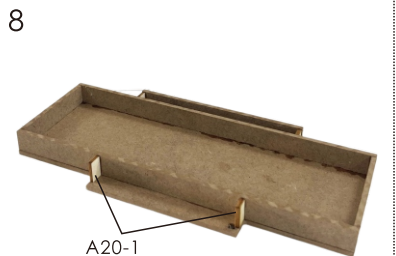
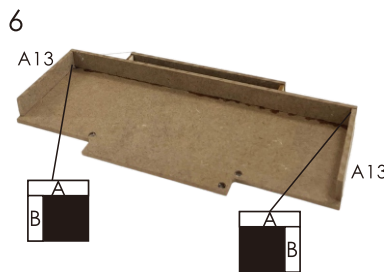
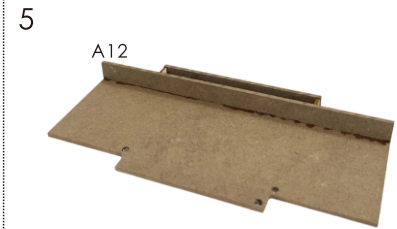
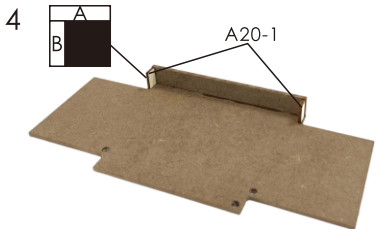
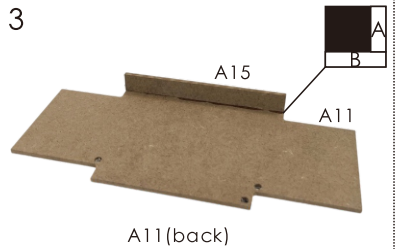
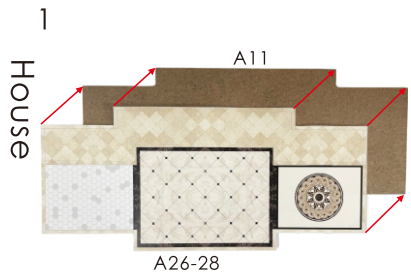
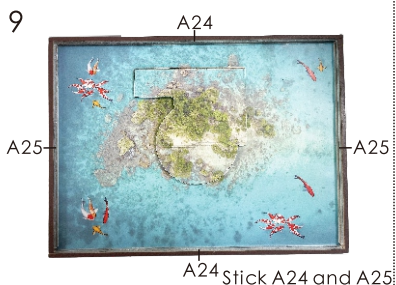
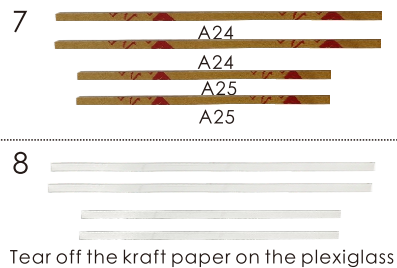

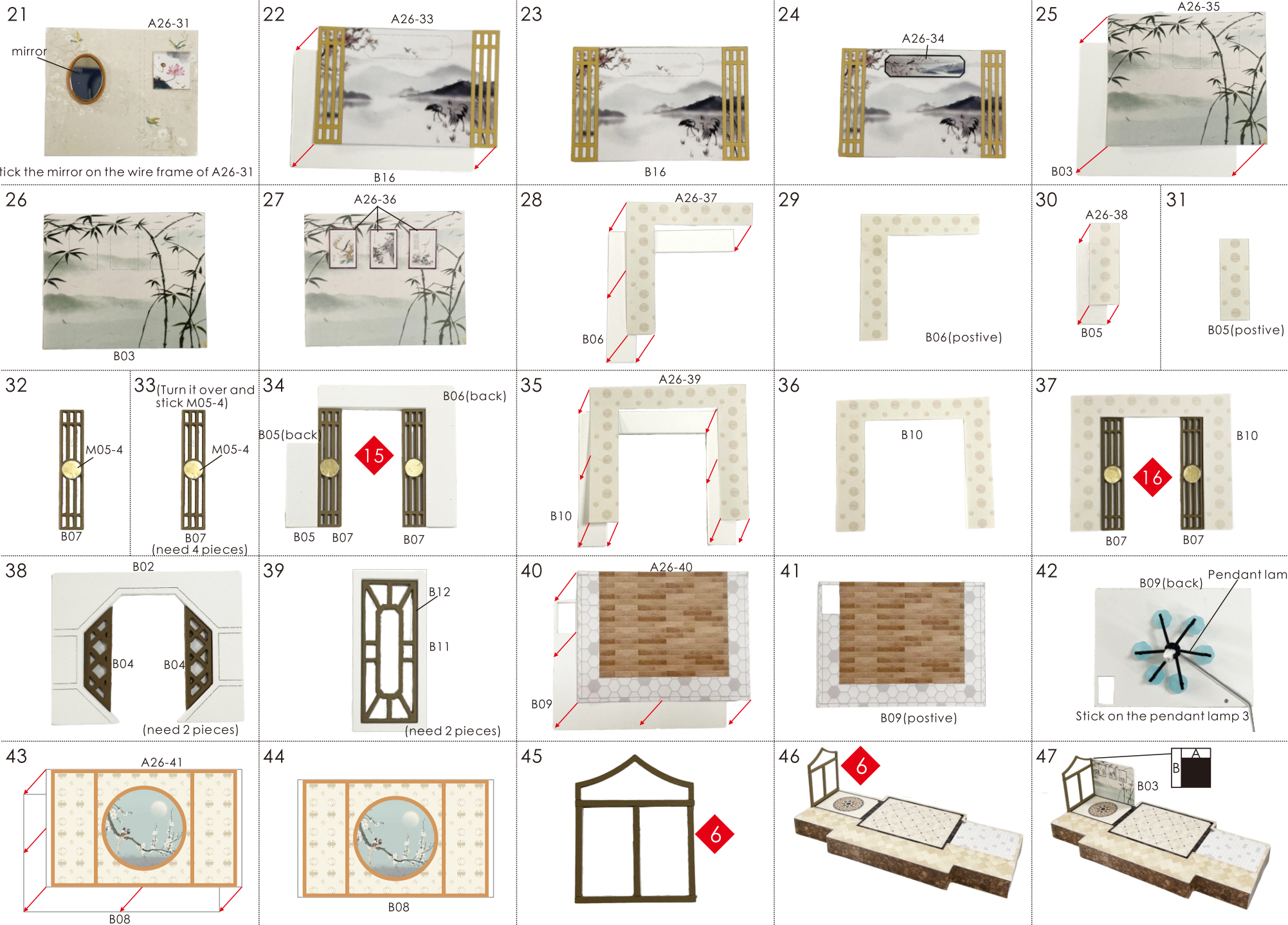

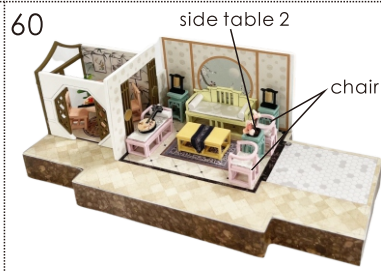
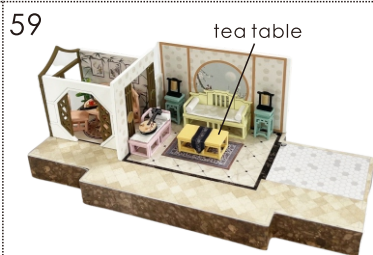
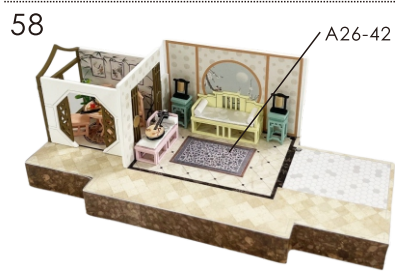
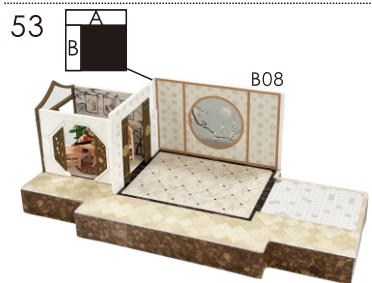
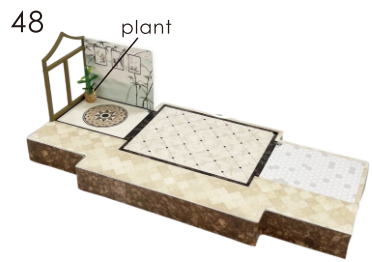

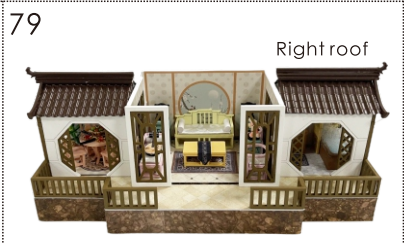
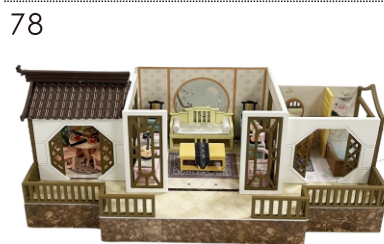
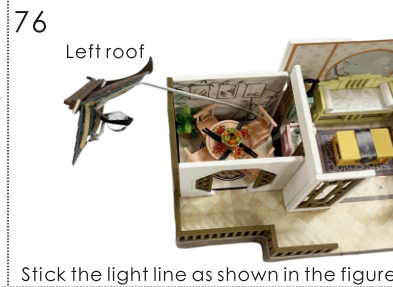
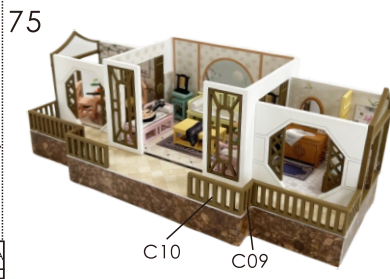

In the same way, stick the roof on the right

Stick B09 as shown in the figure

Cut out A21 according to the template of A21-7, and then stick it

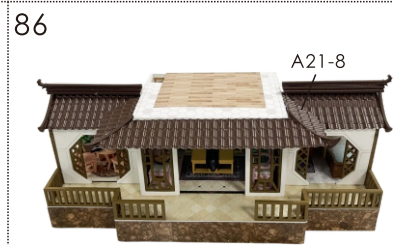

Cut out A21 according to the template of A21-9, and then stick it

Cut out A21 according to the template of A21-8, and then stick it

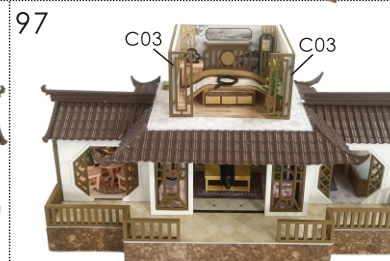
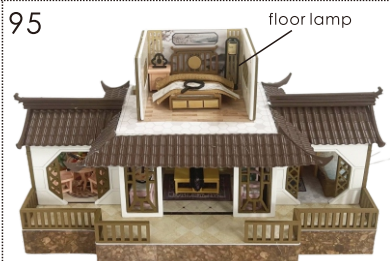
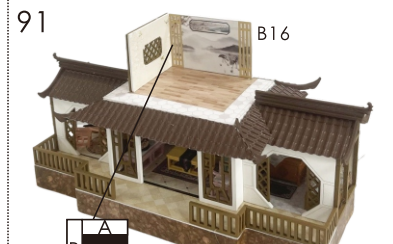
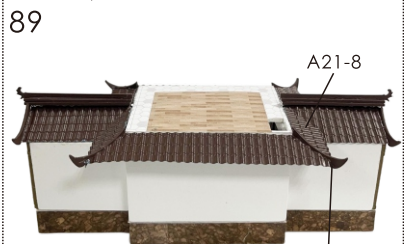

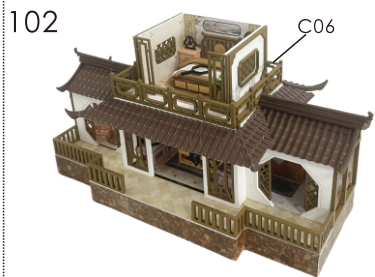

Stick the lantern at the position on the drawing



Pass the light line of the room through panel A02 and fix it



As shown in the figure, stick it on the base

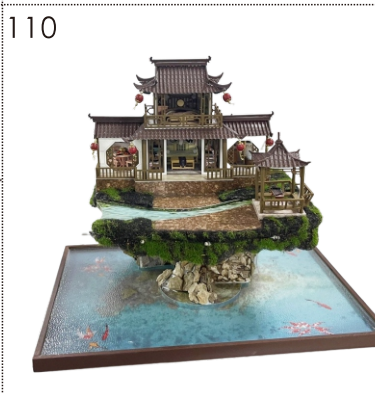

As shown in the picture, stick the waterfall along the river



As shown in the picture, stick the waterfall along the river



As shown in the picture, stick the waterfall along the river



As shown in the picture, stick the waterfall along the river



As shown in the picture, stick the waterfall along the river



Wind and rain bridge

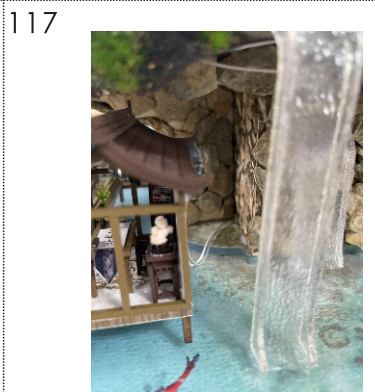

The light line of the library passes through the base as shown in the figure



Cut P04 and paste it on the book at will



Insert P02 into the hole of the panel



Insert P01 into the hole of the panel



Scatter P07 randomly under the tree



Stick the floor lamp



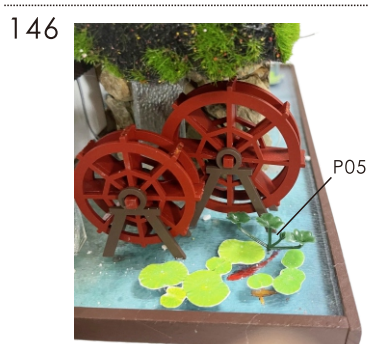
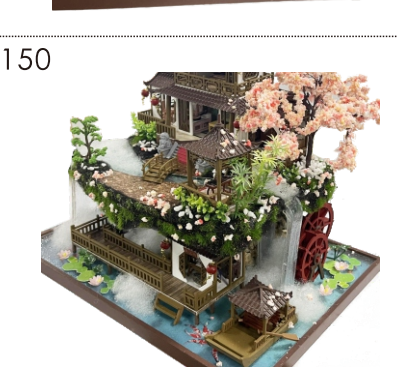
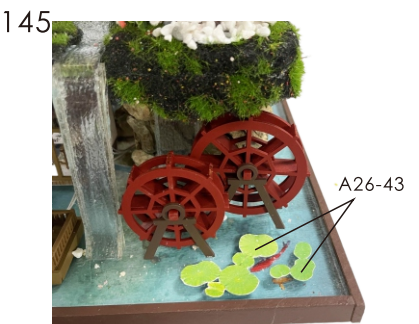
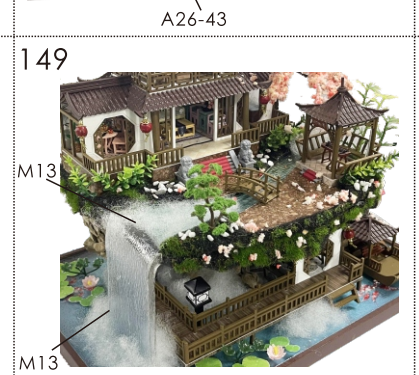
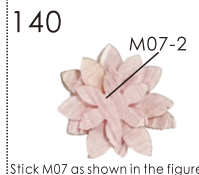

Stick the cherry tree powder on it at will

Installation Of Battery Box

Disclaimer: This wire cannot be plugged into the output socket

- Can use two AAA batteries
- The positive and negative poles of the battery are aligned and the battery is installed
- Non-rechargeable batteries, cannot be charged
- Rechargeable batteries can only be charged under adult supervision
- Rechargeable batteries should be removed from the toy before charging
- Different types of batteries or old and new batteries cannot be mixed
- Batteries should be inserted with correct polarity
- Exhausted batteries should be removed from the toy
- The power terminal must not be short-circuited

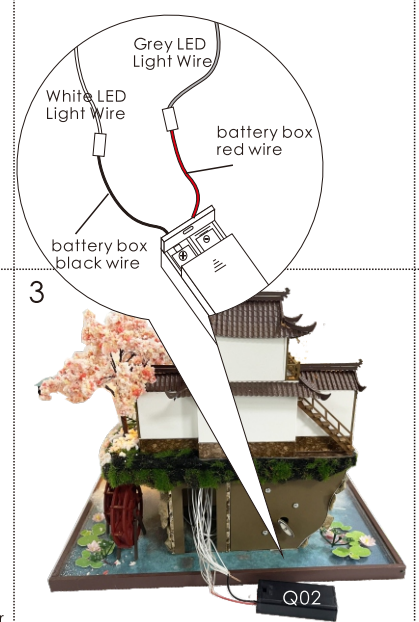

Cut the wires to the same length

Peel off the rubber at the end of the wire and wrap the light wires of the same color together

Wrap the exposed wires with rubber

Installation of dust cover

Dust cover
(Upgrade version accessories need to be purchased separately)



ratio:1:10
Z01 plexiglass(transparent)
30*22*0.18cm(1 piece)



ratio:1:10
Z02 plexiglass(transparent)
30*25*0.18cm(2 pieces)

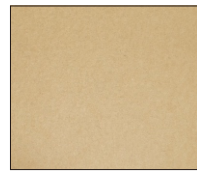

ratio:1:10
Z03 plexiglass(transparent)
25*21.64*0.18(2 pieces)

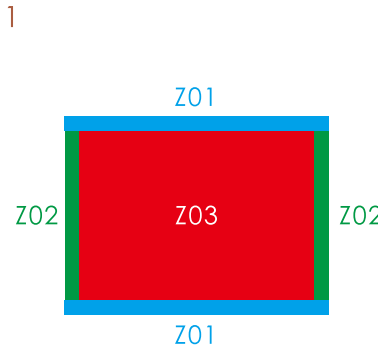

stick Z01 and Z02 on Z03

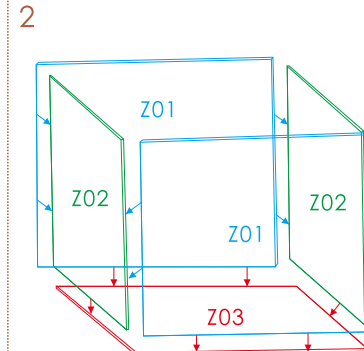

stick five pieces of plexiglass dust cover as shown



Take out the plexiglass and tear off the kraft paper with text on each piece of plexiglass

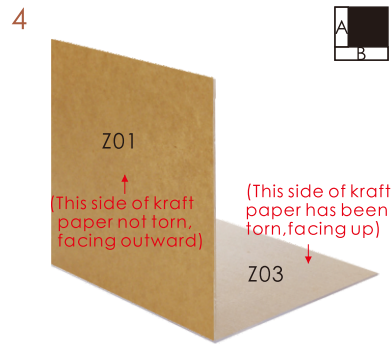

The kraft paper that has been ripped off faces inwards, and the kraft paper that has not been ripped out faces outwards.

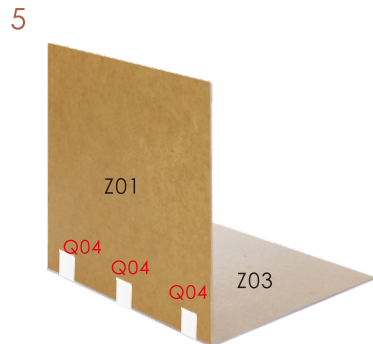

Use Q04 to fix the junction of two pieces of plexiglass. (use transparent tape to replace Q04)

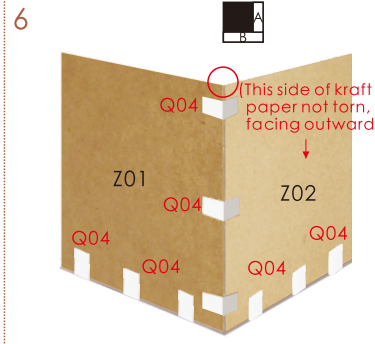

The junction of every two pieces of plexiglass needs to be fixed with Q04 (to prevent the plexiglass falling off)

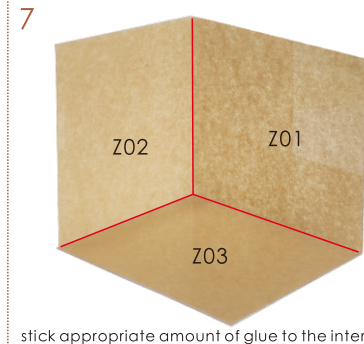

stick appropriate amount of glue to the interface of the two pieces of glass and scrape it slightly to make the glue penetrate into the junction of the two pieces of glass (the red line is the plexiglass interface)



The junction of two pieces of plexiglass needs to be fixed with Q04 (to prevent the plexiglass falling off)

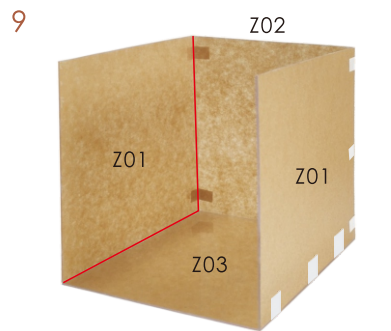

stick appropriate amount of glue to the interface of the two pieces of glass and scrape it slightly to make the glue penetrate into the junction of the two pieces of glass (the red line is the plexiglass interface)

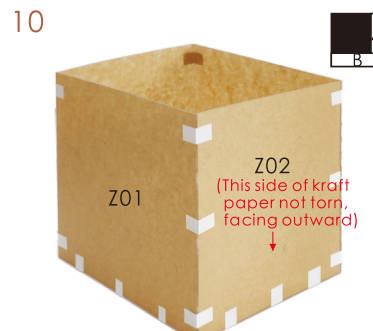

The junction of two pieces of plexiglass needs to be fixed with Q04 (to prevent the plexiglass falling off)

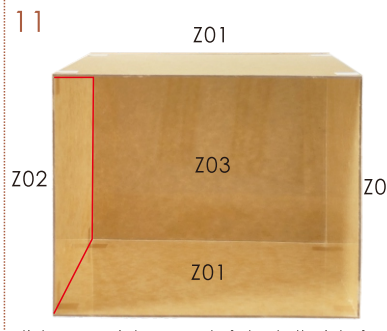

stick appropriate amount of glue to the interface of the two pieces of glass and scrape it slightly to make the glue penetrate into the junction of the two pieces of glass (the red line is the plexiglass interface)

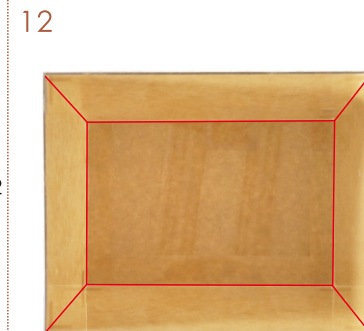

The dust cover need to be glued 8 interfaces

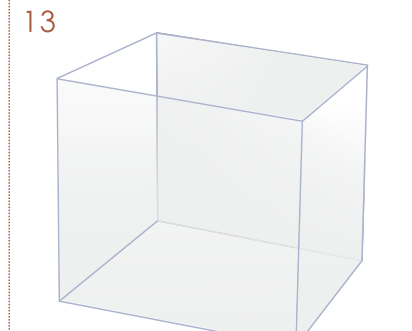

Leave it for 1 hour. After the glue dries out, tear off a layer of kraft paper outside the plexiglass

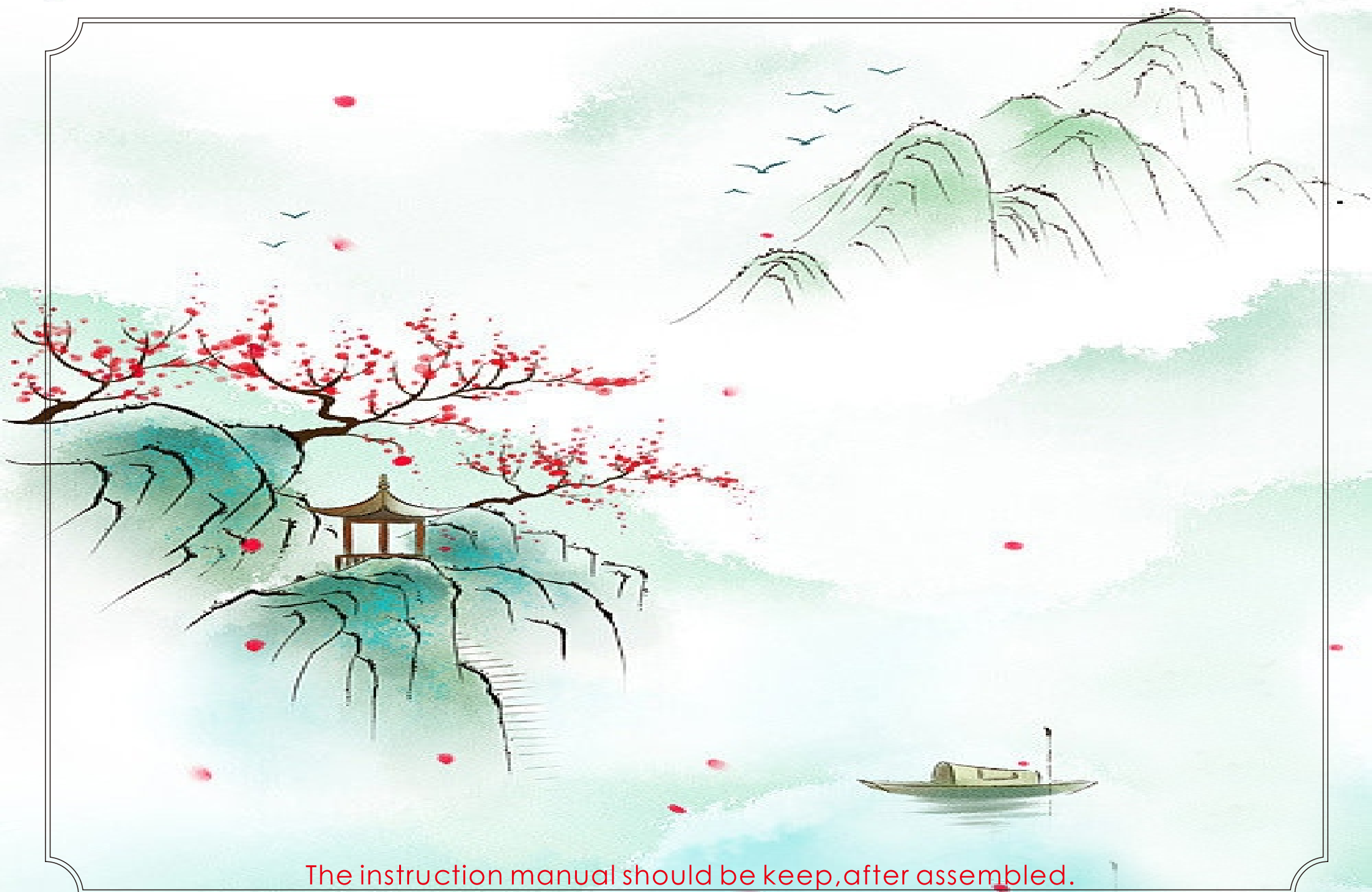

The instruction manual should be keep, after assembled.