

Life Long Love

PC2011



NOTICE OF ASSEMBLE

Tips for assembling

1. Pictures shown on the package may be slightly different from the actual product.
2. All the materials are taken in the operation step, put the remaining materials back into the original pocket until the installation is completed. (Avoid material loss during installation)
3. The dimensions indicated in the step diagram are "cm".
4. If there have template paper material, please cut the material according to the template to avoid mistakes..
5. According to the part rule example at the bottom of this page, refer to the part on the part number drawing, find the material object and compare with the material list, confirm and install. (Wooden parts only)
6. Glue should not be applied too much, so as not to dry longer, overflow will affect the effect of the finished product.
7. Part shapes may differ from the photographs depending on the production batch

Testing on LED function

Be sure to test the LED lights before making the lighting, note that the LED white wire to the negative, gray wire to the positive reference to the following figure operation test.



1 DO NOT contact the LED wire end direct to the battery cell.



2 Use the provide battery holder. Make sure the correct polarity.

How to assemble the battery holder



1. Material and tools needed:
- Battery holder, LED bulb,
tape, screw driver and 2 piece
AAA size battery (not provided)



2. Use screw driver and
take the lid off from the
battery holder.

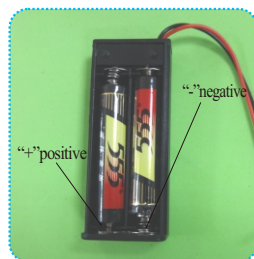

3. Insert the battery and
take notes on the polarity.

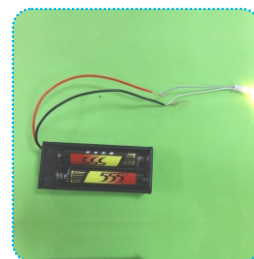

4. Connect the red wire
to grey wire. Connect
the black wire to white
wire.

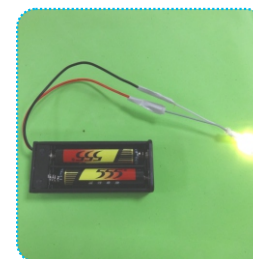

5. Wrap the exposed wire
with the tapes.

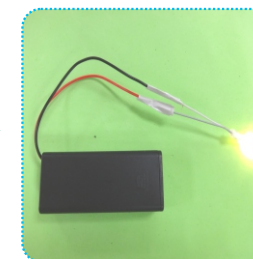

6. Place the box lid and
fasten with screw driver.

Examples of parts rule:

A01: The parts are directly in the box; B01: The parts are in the B bag; C01: The parts are in the C bag, and so on (Note: The printing paper is displayed in the step A08-01 and A09-1: The printing paper is placed directly in the box, The part number is A08-01 and A09-1)

About the use of glue

Method for using glue:

1. After applying the glue, let it dry for a few seconds before pasting.
2. Fix it slightly with your hands, and finally put it aside to dry;

Tips:

When pasting the plane printing paper, a piece of waste bank card or telephone card can be used to wipe evenly after the glue is smeared on the wood board, and then the printing paper is pasted to squeeze out the air inside.

Types of glue:

White latex: Used for adhering soft materials, such as wood and paper.
Alcoholic Glue: Used for adhering hard materials such as cloth, plastic, beads, wire, dust cover, etc.

Contents

Name	Materials Package
Printing paper	Bag A-A08,A09(all printing and template paper are shown on A08 and A09 paper, total 5pieces of A3 and 2pieces of A4)
chair	G bag+ printing paper Page 3
table	G bag+T bag+U bag+V bag..... Page 3
sofa	G bag+U bag Page 4
hearth	A bag+G bag+U bag+V bag+printing paper.....Page 4
bookcase	H bag+U bag+V bag+ printing paper.....Page 4-5
tea table	H bag+T bag+U bag+V bag+printing paper..... Page 5-6
bath bucket	A bag+H bag+T bag+printing paper.....Page 6
dressing table	J bag+T bag+U bag..... Page 6-7
bed	J bagPage 7
master room bed	A bag+K bag +T bag.....Page 7-8
chine	K bag+T bag+V bag+printing paper..... Page 8
armory	A bag+L bag+T bag+U bag+printing paper..... Page 8-10
bridal sedan	A bag+M bag+ printing paper..... Page 10-11
well	M bag+T bag+printing paper..... Page 11
steamed bun shop	N bag+U bag+printing paper.....Page 12
small cart	A bag+N bag +T bag+U bag+printing paper..... Page 12-13
battle flay & war drum	A bag+P bag+Q bag+T bag+U bag+printing paper..... Page 13-14
lights	R bag+U bag+V bag+W bag +printing paper..... Page 14-15
watchtower	A bag+S bag+W bag+printing paper..... Page 15-16
bulletin board	C bag+P bag+S bag+printing paper..... Page 16
steps	F bag+P bag+printing paper..... Page 16-17
rice bag&basket	T bag+U bag+printing paper..... Page 17
city wall	A bag+P bag+Q bag+T bag+W bag+printing paper..... Page 18-20
outer frame	A bag+Bbag+C bag+D bag+E bag+F bag+T bag+W bag+printing paper.....Page 20-28

Welcome to the DIY world, now follow me to start making.

Thumbnail of material list (reference only)

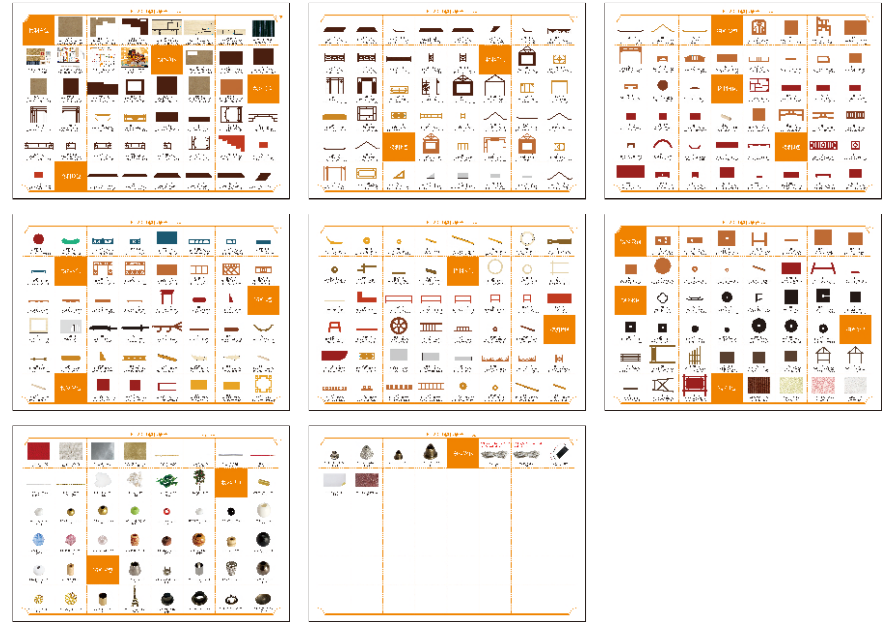



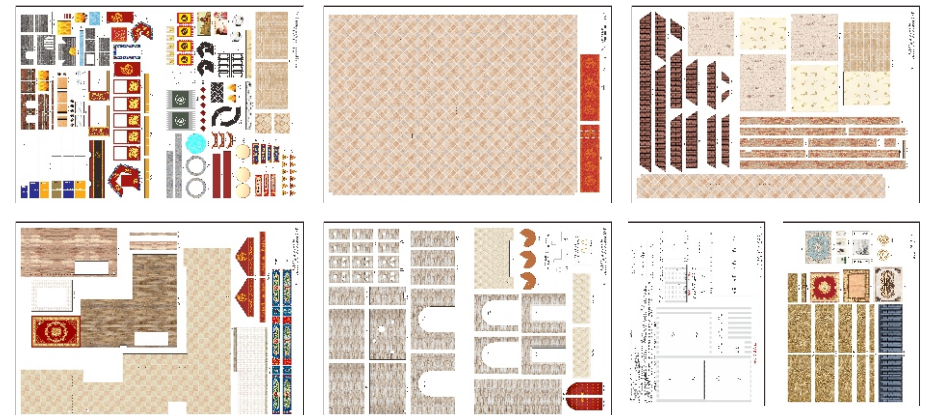



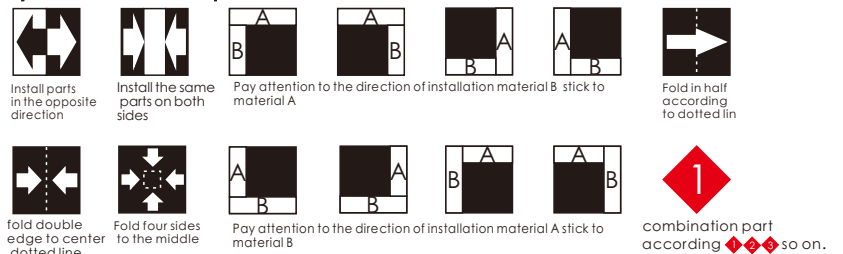

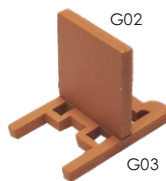







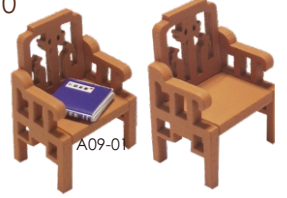

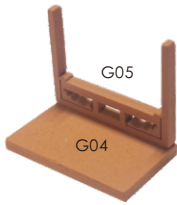
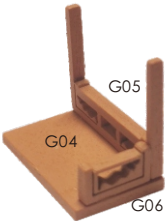
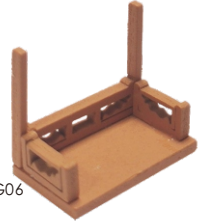



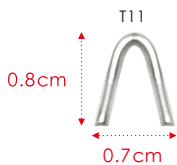

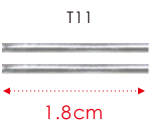



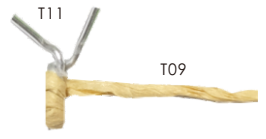









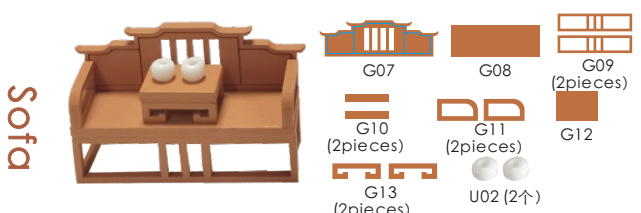
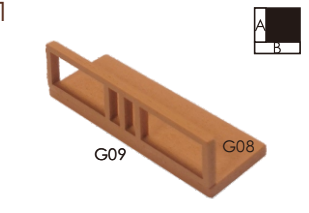
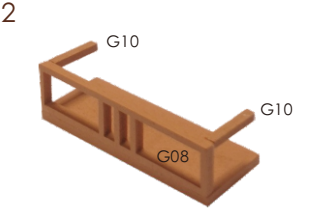
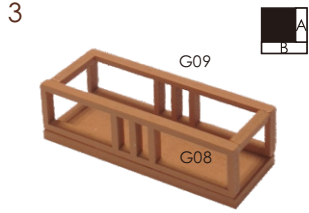



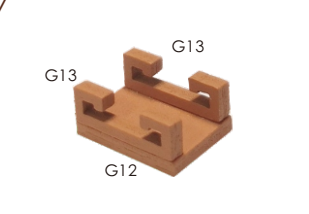

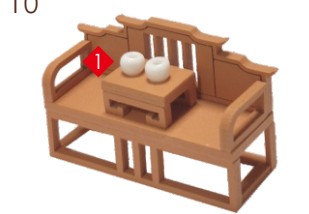

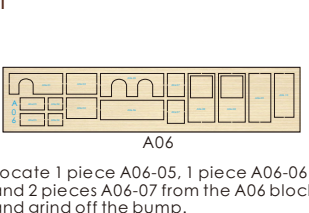

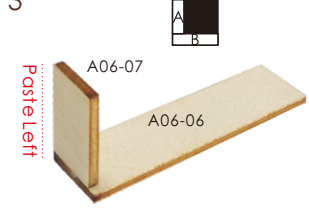
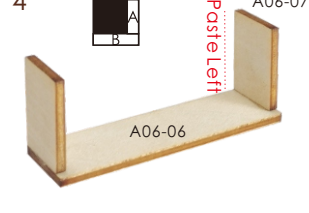
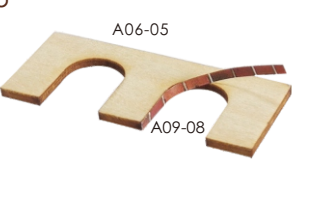
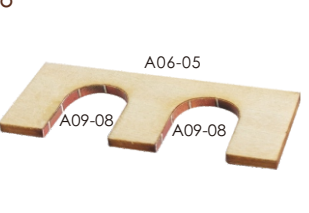
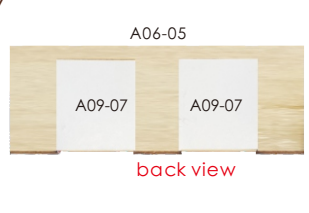
Thumbnail of printing paper & template paper (reference only)

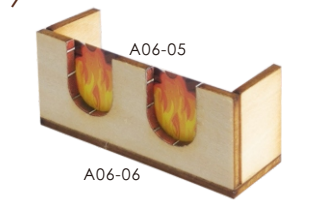

Symbol description used

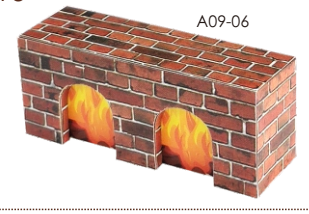

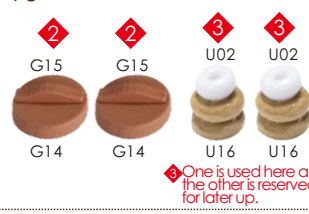
<p>Chair</p>  <p>G01 (2pieces) G02 (2pieces) G03 (4pieces) A09-01</p>	<p>1</p>  <p>G02 G03</p>	<p>2</p>  <p>G03 G02 G03</p>	<p>3</p>  <p>G01</p>	<p>4</p>  <p>Refer to the steps above to make 2pieces.</p>	
<p>5</p>  <p>A09-01</p>	<p>6</p>  <p>A09-01</p>	<p>7</p>  <p>A09-01</p>	<p>8</p>  <p>A09-01</p>	<p>9</p> <p>All books are made the same way.</p>  <p>A09-01</p>	<p>10</p>  <p>A09-01 chair1 chair2</p>
<p>Table</p>  <p>G04 G05 (2pieces) G06 (2pieces) T09 T11 T17 U01 U14 V01 V02 V03 (2个)</p>	<p>1</p>  <p>G05 G04</p>	<p>2</p>  <p>G05 G04 G06</p>	<p>3</p>  <p>G06</p>	<p>4</p>  <p>G05</p>	
<p>5</p> 	<p>6</p>  <p>V02 V01</p>	<p>7</p> <p>For bending, refer to T11 wire teapot templates</p>  <p>T11 1.9cm</p>	<p>8</p>  <p>T11 0.8cm 0.7cm</p>	<p>9</p>  <p>T11</p>	<p>10</p>  <p>teapot U01</p>
<p>11</p>  <p>T11 1.8cm</p>	<p>12</p>  <p>T11 0.9cm</p>	<p>13</p>  <p>T09 Untie one T09 into two.</p>	<p>14</p>  <p>T09 7cm</p>	<p>15</p>  <p>T11 T09 Wrap T11 with T09.</p>	<p>16</p>  <p>T11</p>
<p>17</p>  <p>T09 Untie one T09 into two.</p>	<p>18</p>  <p>T09 3cm</p>	<p>19</p>  <p>T09 T11 Wrap T11 with T09</p>	<p>20</p>  <p>T11 U14</p>	<p>21</p>  <p>T17 T11 potted plant Affix an appropriate amount of T17 to T11.</p>	<p>22</p>  <p>potted plant teapot V03 V03</p>

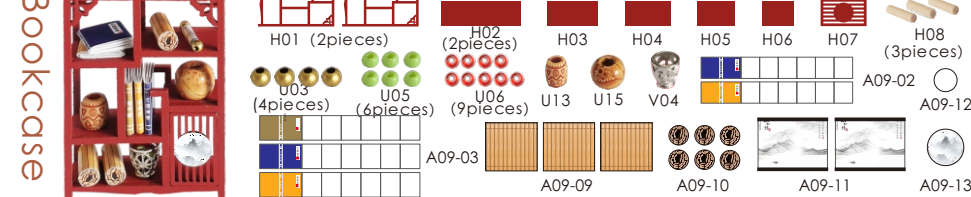
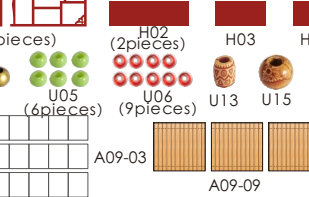
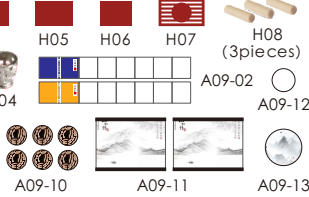
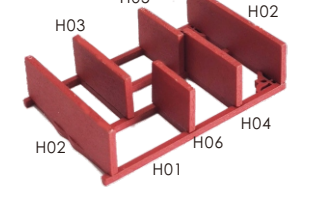
<p>Sofa</p> 	<p>1</p> 	<p>2</p> 	<p>3</p> 	<p>4</p> 	
<p>5</p> 	<p>6</p> 	<p>7</p> 	<p>8</p> 	<p>9</p> 	<p>10</p> 
<p>Hearth</p> 	<p>1</p>  <p>Locate 1 piece A06-05, 1 piece A06-06 and 2 pieces A06-07 from the A06 block and grind off the bump.</p>	<p>2</p>  <p>All wood blocks on A04, A05, A06 need to be sanded down to remove protrusion</p> <p>Rub off the protrusions on both ends of A06-06 with W05</p>	<p>3</p>  <p>Paste Left</p>	<p>4</p>  <p>Paste Left</p>	
<p>5</p> 	<p>6</p> 	<p>7</p>  <p>back view</p>	<p>8</p>  <p>front view</p>	<p>9</p> 	<p>10</p> 
<p>11</p> 	<p>12</p> 	<p>13</p> 	<p>14</p> 	<p>15</p>  <p>One is used here and the other is reserved for later up.</p>	<p>16</p> 
<p>Bookcase</p> 	<p>1</p> 	<p>2</p> 	<p>3</p> 		

<p>4</p> <p>A09-13 H07</p>	<p>5</p> <p>H07</p>	<p>6</p> <p>A09-10 H08</p>	<p>7</p> <p>H08 A09-10 Flip H08 to the other sides.</p>	<p>8</p> <p>A09-09</p>	<p>9</p> <p>H08</p>
<p>10</p> <p>H08 H08 H08 Make 3pieces.</p>	<p>11</p> <p>A09-12 V04</p>	<p>12</p> <p>U05 U06 V04</p>	<p>13</p> <p>A09-11</p>	<p>14</p> <p>A09-11</p>	<p>15</p> <p>U03 A09-11 U03</p>
<p>16</p> <p>A09-11 A09-11 Make two. Use one here and leave the other for later.</p>	<p>18</p> <p>A09-02 H08 A09-11 U13 U15 A09-03 H08 H08 V04</p>	<p>Tea table</p> <p>H09 H10 (2pieces) H11 (2pieces) H12 (2pieces) H13 (4pieces) T10 T14 (2pieces) U01 (2pieces) U03 (3pieces) V05 (2pieces) V06 (2pieces) V07 (2个) V08 (2个) U09 V10 V11 A08-21</p>			<p>1</p> <p>H10 H09</p>
<p>17</p> <p>A09-02 A09-03 Please refer to the previous steps for the folding of books.</p>	<p>2</p> <p>H10 H11 H09</p>			<p>5</p>	
<p>6</p> <p>T14 6.6cm</p>	<p>7</p> <p>A08-21 T14</p>	<p>8</p> <p>A08-21</p>	<p>9</p> <p>A08-21</p>	<p>10</p> <p>V05 V07</p>	<p>11</p> <p>V06 V05 V07</p>
<p>12</p> <p>U03</p>	<p>13</p> <p>When making, refer to T10 wire teapot template for bending.</p> <p>T10 2cm</p>	<p>14</p> <p>T10 0.8cm 0.7cm</p>	<p>15</p> <p>T10 U01</p>	<p>16</p> <p>U01 Make two. Use one here and leave the other for later.</p>	<p>17</p> <p>Front fabrication tea table V08 V08</p>

<p>18</p>	<p>19</p>	<p>20</p> <p>make two pieces.</p>	<p>21</p>	<p>22</p>	<p>23</p>
<p>24</p>	<p>25</p>	<p>26</p>	<p>27</p>		
<p>Bath Bucket</p>	<p>1</p>	<p>2</p>	<p>3</p>	<p>4</p>	
<p>5</p>	<p>6</p>	<p>7</p>	<p>8</p>	<p>9</p>	<p>10</p>
<p>Dressing table</p> <p>Please cut out T08 according to the template paper before making.</p>	<p>1</p>	<p>2</p>	<p>3</p>	<p>4</p>	
<p>5</p>	<p>6</p>	<p>7</p>	<p>8</p>	<p>9</p>	<p>10</p>

<p>11</p> <p>makeup case</p>	<p>12</p> <p>U07 U08 U10 U11</p>	<p>13</p> <p>dressing table makeup case</p>	<p>14</p> <p>J09 J08</p>	<p>15</p>	<p>16</p> <p>dressing table</p>
<p>Bed</p>		<p>1</p> <p>J16 J15</p>	<p>2</p> <p>J15 J17</p>	<p>3</p> <p>J16 J15</p>	<p>4</p> <p>J17</p>
<p>5</p> <p>J13</p>	<p>6</p> <p>J14</p>	<p>7</p> <p>front fabrication bed</p>	<p>8</p> <p>J19 J19 J18</p>	<p>9</p>	<p>10</p> <p>bed</p>
<p>Master room bed</p>	<p>Please cut out T02, T03 and T04 according to the template paper before making.</p>	<p>1</p> <p>K07 K03</p>	<p>2</p> <p>K08 K03 K08</p>	<p>3</p> <p>K07 K03</p>	<p>4</p>
<p>5</p> <p>K02 K03</p>	<p>6</p> <p>K05 K05</p>	<p>7</p> <p>A06-10 T02 (mattress)</p>	<p>8</p> <p>A06-10</p> <p>Fold four sides to the middle</p>	<p>9</p> <p>A06-10</p>	<p>10</p> <p>A06-10</p>
<p>11</p> <p>T03 (pillow)</p> <p>Fold in half</p>	<p>12</p> <p>T03 (pillow)</p> <p>Seal both sides of the red line with glue.</p>	<p>13</p> <p>T03 (pillow) T15</p> <p>Stuff with cotton.</p>	<p>14</p> <p>pillow</p> <p>seal the opening with glue.</p>	<p>15</p> <p>pillow</p>	<p>16</p> <p>K06 K06</p>

<p>17</p>	<p>18</p> <p>T04(mosquito net)</p>	<p>19</p>	<p>20</p>	<p>21</p>	<p>22</p> <p>master room bed</p>
<p>Chime</p>		<p>1</p>	<p>2</p>	<p>3</p>	<p>4</p> <p>3cm</p>
<p>5</p> <p>Cross V16 with T12.</p>	<p>6</p> <p>Tie V16 to K11.</p>	<p>7</p> <p>Tie another V16 to the K11.</p>	<p>8</p> <p>2cm</p>	<p>9</p> <p>Cross V17 with T12.</p>	<p>10</p> <p>Tie V17 to K11.</p>
<p>Armory</p> <p>Before making, please cut out T07 according to the template paper</p>					
<p>1</p>	<p>2</p>	<p>3</p> <p>back view</p>	<p>4</p> <p>front view</p>	<p>5</p>	<p>6</p>
<p>7</p> <p>back view</p>	<p>8</p> <p>front view</p>	<p>9</p>	<p>10</p>	<p>11</p>	<p>12</p>

<p>13</p> <p>A09-15</p>	<p>14</p> <p>A09-18</p>	<p>15</p> <p>A09-18</p>	<p>16</p> <p>A09-18</p>	<p>17</p> <p>A06-03 A06-04</p>	<p>18</p> <p>A06-03 A06-04</p>
<p>19</p> <p>A06-03</p>	<p>20</p> <p>L01 A09-21</p>	<p>21</p> <p>L01 A09-25</p>	<p>22</p> <p>A09-23 L01</p>	<p>23</p> <p>L01</p>	<p>24</p> <p>A09-26 A09-24</p>
<p>25</p> <p>A09-24 A09-26</p> <p>Flip the image above to the other sides.</p>	<p>26</p> <p>L04 T07-2</p> <p>Use T07-2 to make a circle around the L04 sides.</p>	<p>27</p> <p>L04 T07-2</p>	<p>28</p> <p>T07-1 L04</p>	<p>29</p> <p>T07-1 L04</p> <p>Flip L04 to the other sides.</p>	<p>30</p> <p>L04</p> <p>Make two. Use one here and leave the other for later.</p>
<p>31</p> <p>L03 T07-5</p> <p>Use T07-5 to make a circle around the L03 sides.</p>	<p>32</p> <p>L03 T07-5</p>	<p>33</p> <p>T07-3 L03</p>	<p>34</p> <p>T07-4 L03</p> <p>Flip L03 to the other sides.</p>	<p>35</p> <p>L03</p> <p>Make two. Use one here and leave the other for later.</p>	<p>36</p> <p>L04 L03</p> <p>weapon furnace</p>
<p>37</p> <p>L06 L06 L06 L05</p>	<p>38</p> <p>L05</p>	<p>39</p> <p>L07 L07</p>	<p>40</p> <p>L04 L03</p> <p>weapon rack</p>	<p>41</p> <p>T13 3.2cm</p>	<p>42</p> <p>L08 T13</p>
<p>43</p> <p>L08 T13</p>	<p>44</p> <p>L09 T13</p>	<p>45</p> <p>L13 L11 L10</p>	<p>46</p> <p>T13 10cm</p>	<p>47</p> <p>T13</p>	<p>48</p> <p>T13</p>

<p>49</p> <p>U04</p>	<p>50</p> <p>Refer to the steps above to make 2pieces.</p>	<p>51</p> <p>L12 L12</p>	<p>52</p>	<p>53</p> <p>A09-20 L16</p>	<p>54</p> <p>A09-20 L16</p>
<p>55</p> <p>L16 L16</p> <p>Refer to above steps to make 2pieces.</p>	<p>56</p> <p>L14 T07-8</p> <p>Use T07-8 to circle L14 sides.</p>	<p>57</p> <p>L14 T07-8</p>	<p>58</p> <p>T07-7 L14</p>	<p>59</p> <p>T07-6 L14</p> <p>Flip L14 to the other sides.</p>	<p>60</p> <p>L14 L16</p> <p>long knife</p>
<p>61</p> <p>T07-10 L15</p> <p>Use T07-10 to circle L15 sides.</p>	<p>62</p> <p>L15 T07-10</p>	<p>63</p> <p>T07-9 L15</p>	<p>64</p> <p>T07-9 L15</p> <p>Flip L15 to the other sides.</p>	<p>65</p> <p>L15 L16</p> <p>pike</p>	<p>66</p> <p>L14 L16 L17</p> <p>long knife pike</p> <p>fall station</p>
<p style="writing-mode: vertical-rl; transform: rotate(180deg);">Bridal sedan</p>		<p>1</p> <p>A09-33 M02</p>	<p>2</p> <p>M02</p>	<p>3</p> <p>M02 M01</p> <p>Affix M02 in the middle of M01.</p>	
<p>4</p> <p>A09-30 A06-08</p>	<p>5</p> <p>A09-30 A06-08</p> <p>Flip A06-08 to the other sides.</p>	<p>6</p> <p>M06 A06-08</p>	<p>7</p> <p>A06-08 A06-08</p> <p>make 2pieces.</p>	<p>8</p> <p>A06-08 M02</p>	<p>9</p> <p>A09-34 A06-09</p>
<p>10</p> <p>A06-08 A06-09</p>	<p>11</p> <p>A06-08 A06-09</p>	<p>12</p> <p>A06-08 A09-31</p>	<p>13</p> <p>A09-31</p>	<p>14</p> <p>M05 M04</p>	<p>15</p> <p>A06-08</p>

<p>16</p>	<p>17</p>	<p>18</p> <p>Fold A09-35 along the black links.</p>	<p>19</p>	<p>20</p>	<p>21</p>
<p>22</p> <p>Fold A09-29 along the black links.</p>	<p>23</p>	<p>24</p>	<p>25</p>	<p>26</p>	<p>27</p>
<p>28</p>	<p>29</p>	<p>30</p>	<p>31</p> <p>Flip the image above to the other sides.</p>	<p>32</p>	<p>33</p>
<p>Well</p>	<p>1</p>	<p>2</p>	<p>3</p>	<p>4</p>	
<p>5</p>	<p>6</p>	<p>7</p>	<p>8</p>	<p>9</p> <p>Untie one T09 into two.</p>	<p>10</p>
<p>11</p>	<p>12</p>	<p>13</p>	<p>14</p>	<p>15</p>	

Steamed bun shop

1 **Plan view**

2

3

4

5

6

7

8

9

10

11

12

13

14

15

16

17

18

19

20

21

22

23

24

25

26

Small Cart

1

2

3

4











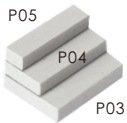



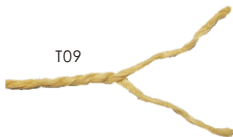

12

<p>5</p>  <p>N16 N16</p>	<p>6</p>  <p>A04-11 T05 wine jar</p>	<p>7</p>  <p>T05 wine jar U17</p>	<p>8</p>  <p>T05 wine jar U17</p>	<p>9</p>  <p>T09 Untie one T09 into two.</p>	<p>10</p>  <p>T09 6.5cm</p>	
<p>11</p>  <p>T05 wine jar T09</p>	<p>12</p>  <p>T09</p>	<p>13</p>  <p>wine jar A09-44</p>	<p>14</p>  <p>Make six. Use one here and leave the other five for later.</p>	<p>15</p>  <p>wine jar</p>		
<p>Battle flag & War drum</p>	 <p>A04-06 (4pieces) A04-14 (2pieces) P13 (2pieces) P14 (2pieces) P15 (2pieces) P16 (2pieces) Q13 Q14 (2pieces) Q15 (2pieces) T12 U03 (2pieces) A09-46 A09-47 A09-48 A09-49 A09-50</p>			<p>1</p>  <p>P15 P14 P13</p>	<p>2</p>  <p>P16 A09-46</p>	<p>3</p>  <p>U03 A09-46</p>
	<p>4</p>  <p>T12 12cm</p>	<p>5</p>  <p>T12</p>	<p>6</p>  <p>T12</p>	<p>7</p>  <p>T12</p>	<p>8</p>  <p>make 2pieces</p>	<p>9</p>  <p>A04-06 A04-06 A04-06 A04-06 Affix 4 pieces of A04-06 together</p>
<p>10</p>  <p>25</p>	<p>11</p>  <p>A09-47 25</p>	<p>12</p>  <p>A09-47 25</p>	<p>13</p>  <p>A09-47 25</p>	<p>14</p>  <p>A09-50 25</p>	<p>15</p>  <p>A09-50 25 Flip 25 to the other sides</p>	
<p>16</p>  <p>A09-49 A04-14</p>	<p>17</p>  <p>A04-14 A04-14 make 2pieces.</p>	<p>18</p>  <p>A09-48 A04-14 A04-14 Faces with printed paper facing outward</p>	<p>19</p>  <p>A09-48 A04-14 A04-14 Faces with printed paper facing outward</p>	<p>20</p>  <p>A09-48 26</p>	<p>21</p>  <p>25 26</p>	

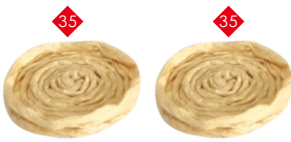

<p>25</p>  <p>A09-55</p> <p>Fold over A09-55 white dotted links</p>	<p>26</p>  <p>A09-55 R09 W01</p>	<p>27</p>  <p>R08 R06</p>	<p>28</p>  <p>A09-55 W01</p>	<p>29</p>  <p>W01</p> <p>Paste the wiring of W01 as shown.</p>	<p>30</p>  <p>R07</p>
<p>31</p>  <p>A09-54</p> <p>Fold over A09-55 white links</p>	<p>32</p>  <p>A09-54 R05</p>	<p>33</p>  <p>R05 A09-54</p>	<p>34</p>  <p>R05</p>	<p>35</p>  <p>R11 R10 R05</p>	<p>36</p>  <p>light No.5</p>
<p>37</p>  <p>R09 W01</p>	<p>38</p>  <p>A09-51</p>	<p>39</p>  <p>A09-51 R09 W01</p>	<p>40</p>  <p>A09-51 W01</p>	<p>41</p>  <p>R13 R12</p>	<p>42</p>  <p>make 2pieces</p>
<p>43</p>  <p>A09-51 R30</p>	<p>44</p>  <p>A09-52 R14</p>	<p>45</p>  <p>A09-52 R14</p>	<p>46</p>  <p>A09-52 R30</p>	<p>47</p>  <p>R30</p>	<p>48</p>  <p>light No.6</p>
<p>Watchtower</p>  <p>watchtower No.1 watchtower No.2</p>	 <p>S04(2pieces) S05 (2pieces) S06 (2pieces) S07 (2pieces) S08 (2pieces) S09 (4pieces) S10(8pieces) W01(1pieces) A07 watchtower roof A09-69</p> <p>Please cut out A07 according to the template paper before making.</p>	<p>1</p>  <p>S05 S06</p>	<p>2</p>  <p>A07 watchtower roof</p>	<p>3</p>  <p>A07 watchtower roof</p>	<p>4</p>  <p>S07</p>
<p>5</p>  <p>S09 S07</p>	<p>6</p>  <p>S08 S31</p>	<p>7</p>  <p>S10</p>	<p>8</p>  <p>S10</p>	<p>9</p>  <p>S10 S32</p>	<p>10</p>  <p>A09-69 S04</p>

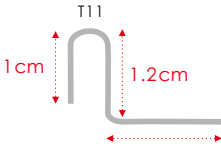
<p>11</p>  <p>S04</p>	<p>13</p>  <p>watchtower No.1</p>	<p>14</p>  <p>Refer to the previous steps to make another.</p>	<p>15</p>  <p>W01</p> <p>Paste W01 into</p>	<p>18</p>  <p>W01</p>	<p>19</p>  <p>W01</p> <p>watchtower No.2</p> <p>Paste the lamp line as shown in the figures</p>
<p>12</p>  <p>S04</p>		<p>16</p>  <p>W01</p> <p>Paste the light line as shown in the figures</p>	<p>17</p>  <p>Refer to the previous steps to make another</p>		
<p>Bulletin board City gate Stairs</p>  <p>1 S11</p> <p>2 S11 back view bulletin board</p> <p>3 P01 A09-128</p> <p>4 A09-127 P01</p>					
<p>5</p>  <p>P01 P01</p> <p>city gate</p>	<p>6</p>  <p>C17 C15</p>	<p>7</p>  <p>C17 C15 C16</p>	<p>8</p>  <p>C17 C17 C17 C17 C17 C16 C16 C16 C16 C16</p> <p>stairs</p>	<p>9</p>  <p>stairs</p>	
<p>Steps</p>  <p>steps No.1</p> <p>steps No.2 (3pieces)</p> <p>steps No.4 (2pieces)</p> <p>steps No.3 (2pieces)</p> <p>1 A05-21 A05-20 A05-19</p> <p>2 A09-72</p> <p>3 A09-72</p> <p>Fold along A09-72 white dotted links</p>					
<p>4</p>  <p>steps No.1</p> <p>F09</p>	<p>5</p>  <p>F12 F11 F10</p>	<p>6</p>  <p>F09</p> <p>steps No.2</p>	<p>7</p>  <p>steps No.2 steps No.2 steps No.2</p> <p>make 3pieces</p>	<p>8</p>  <p>F12 F11 F10</p> <p>steps No.3</p>	<p>9</p>  <p>steps No.3 steps No.3</p> <p>make 2pieces.</p>

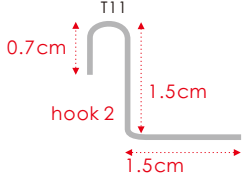
<p>10</p>  <p>steps No.4</p>	<p>11</p> <p>steps No.4 steps No.4</p>  <p>make 2pieces.</p>				
<p style="writing-mode: vertical-rl; transform: rotate(180deg);">Rice bag&Basket</p>  <p>basket No.1 hook 1</p> <p>basket No.2 hook 2</p>	 <p>U05 (14pieces) U06 (17pieces) T09</p> <p>T06 rice bags T11</p> <p>T15 A09-45</p> <p>Before making, please cut out T06 according to the template paper.</p>	<p>1</p>  <p>T06 rice bags</p>	<p>2</p>  <p>T06 rice bags Fold in half.</p>	<p>3</p>  <p>T06 rice bags</p> <p>Seal both sides of the red line with glue</p>	<p>4</p>  <p>T06 rice bags</p> <p>Stuff with cotton.</p>
<p>5</p>  <p>T09</p> <p>Untie one T09 into two.</p>	<p>6</p>  <p>T09</p> <p>5cm</p>	<p>7</p>  <p>T09</p> <p>T06 rice bags</p>	<p>8</p>  <p>T09</p> <p>T06 rice bags</p> <p>cut off excess T09</p>	<p>9</p>  <p>rice bag</p> <p>A09-45</p>	<p>10</p>  <p>rice bag rice bag rice bag rice bag</p> <p>make 4pieces</p>
<p>11</p>  <p>T09</p> <p>Untie one T09 into two.</p>	<p>12</p>  <p>T09</p> <p>26cm</p>	<p>13</p>  <p>T09</p>	<p>14</p>  <p>T09</p> <p>34</p> <p>1.6cm</p>	<p>15</p>  <p>T09</p> <p>5.2cm</p>	<p>16</p>  <p>T09</p> <p>34</p> <p>wrap with T09.</p>
<p>17</p>  <p>35</p>	<p>18</p>  <p>35 35</p> <p>make 2pieces.</p>	<p>19</p>  <p>U05</p> <p>35</p> <p>basket No.1</p>	<p>20</p>  <p>U06</p> <p>35</p> <p>basket No.2</p>	<p>21</p> <p>During fabrication, refer to T11 wire hook 1 template for bending</p>  <p>T11</p> <p>4cm</p>	<p>22</p>  <p>T11</p> <p>1cm 1.2cm</p> <p>Hook 1 1.5cm</p>
<p>23</p> <p>During fabrication, refer to T11 wire hook 2 template for bending</p>  <p>T11</p> <p>4cm</p>	<p>24</p>  <p>T11</p> <p>0.7cm 1.5cm</p> <p>hook 2 1.5cm</p>				

City wall



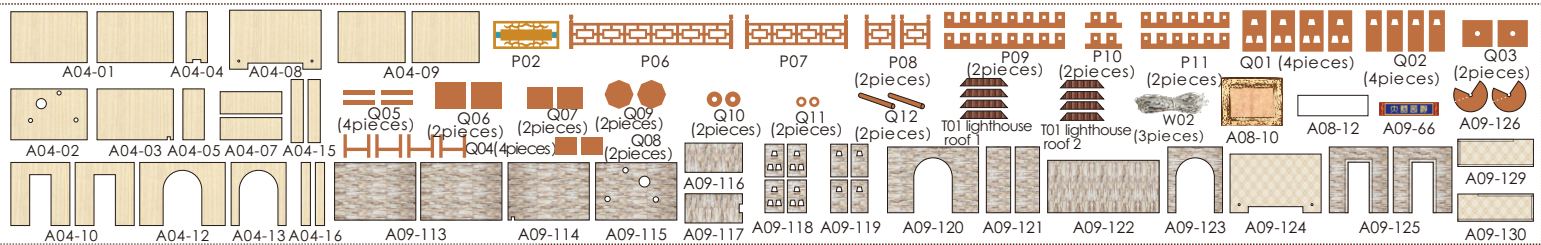



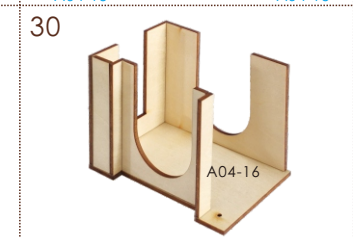
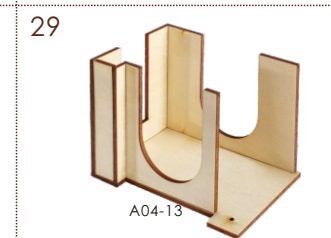
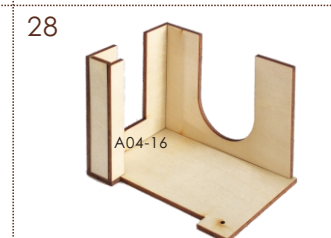
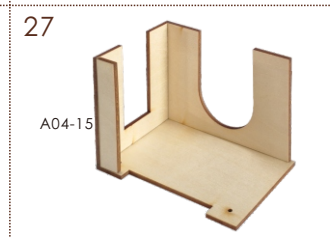
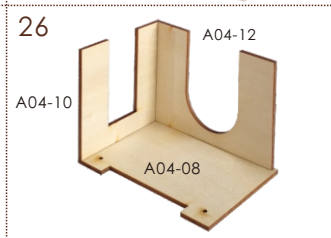
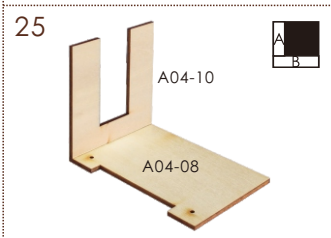
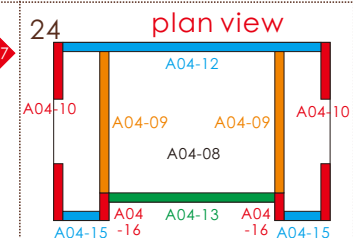
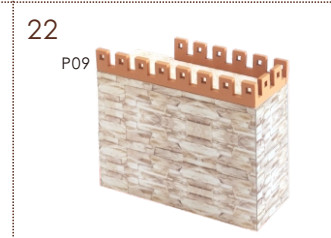
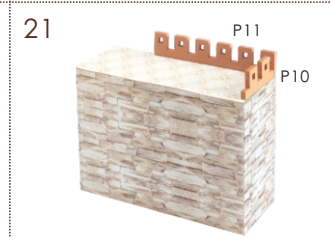
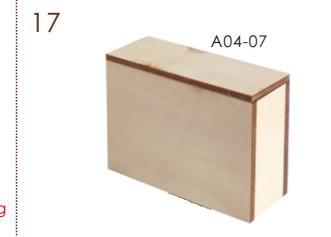
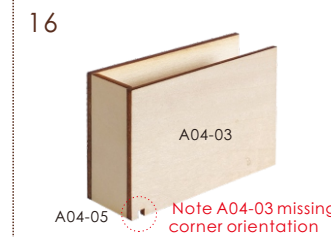
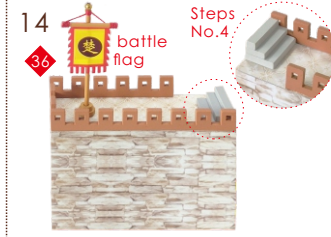
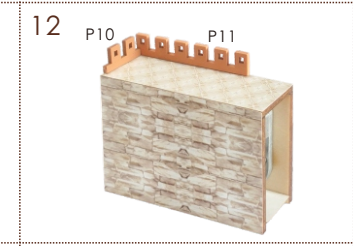
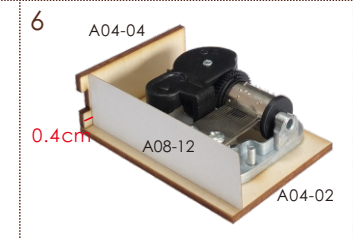
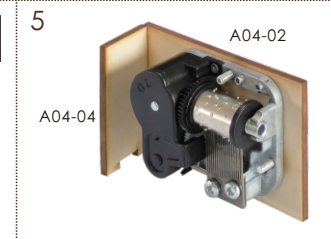

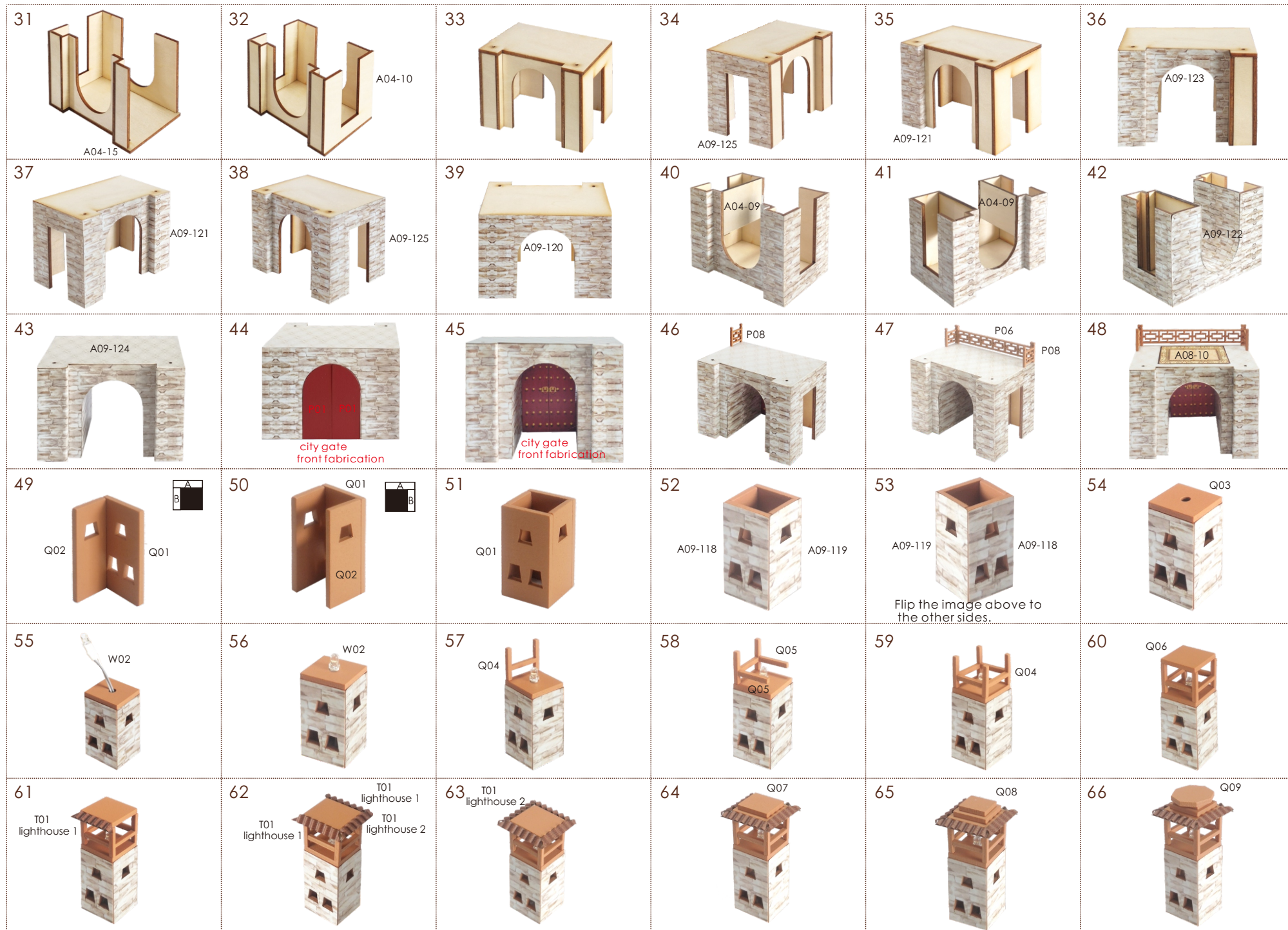



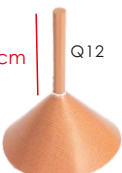



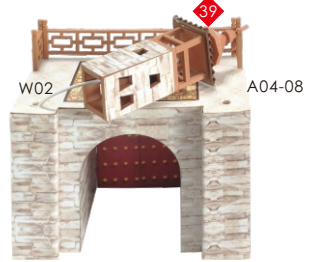



Before making, please cut out T01 according to the template paper.

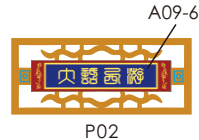





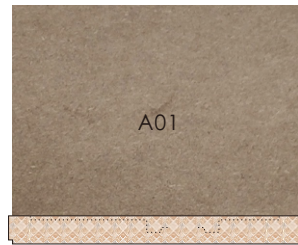
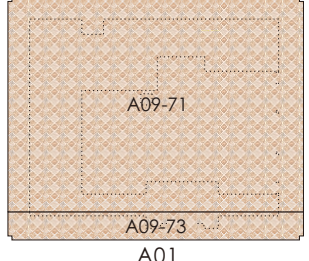

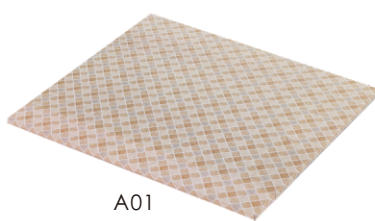
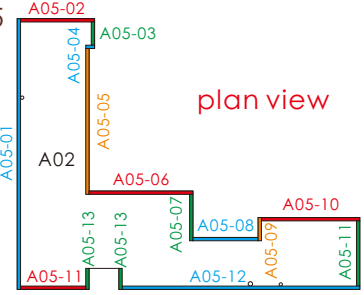
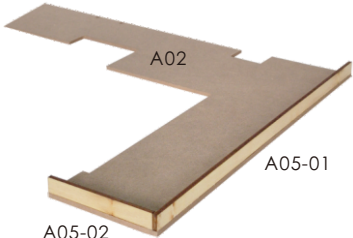
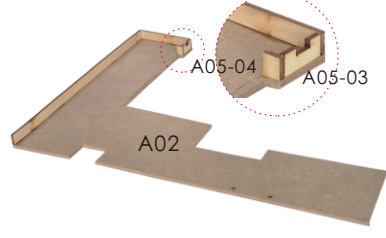
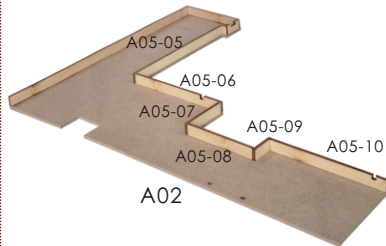
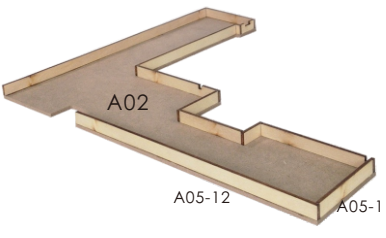
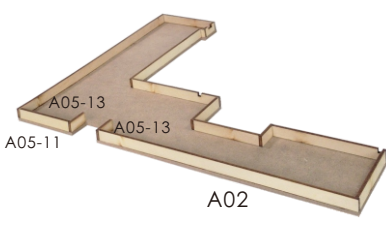

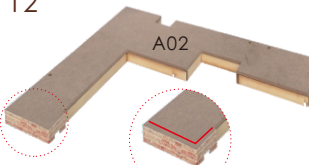
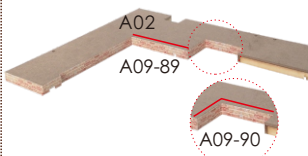
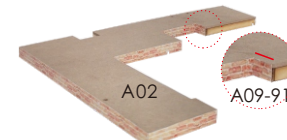
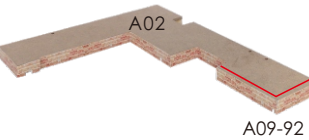
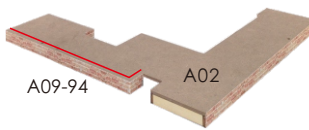
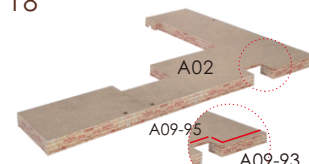
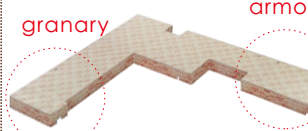
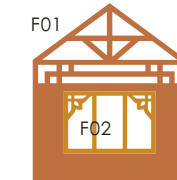

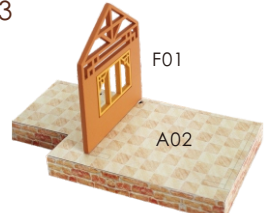
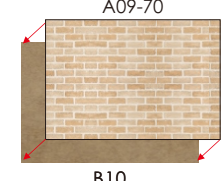





1 upgraded version (accessories need to be purchased separately)



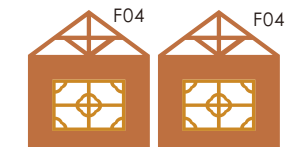
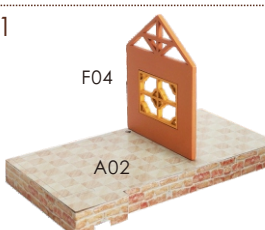
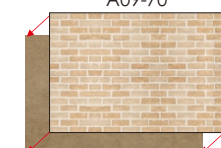
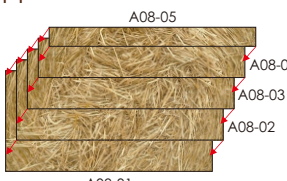

<p>67</p>  <p>A09-126</p>	<p>68</p>  <p>A09-126</p>	<p>69</p>  <p>1.4cm Q12</p> <p>A09-126</p>	<p>70</p>  <p>Q11 Q10</p>	<p>71</p>  <p>38</p>	<p>72</p>  <p>39 39</p> <p>make 2 pieces</p>
<p>73</p>  <p>W02 A04-08</p> <p>Thread  of W02 into A04-08.</p>	<p>74</p>  <p>39</p>	<p>75</p>  <p>39</p> <p>paste second </p> <p>Centralize the light wires here</p>	<p>76</p>  <p>P07</p>	<p>77</p>  <p>A09-66</p> <p>P02</p>	
<p>78</p>  <p>war drum</p> <p>P02</p>	<p>79</p>  <p>W02</p> <p>16cm</p>	<p>80</p>  <p>W02</p> <p>9cm</p>	<p>81</p>  <p>Centralize the light wires here</p> <p>W02</p>	<p>81</p>  <p>36 37</p>	
<p>1</p> <p>Outer frame</p>  <p>A01</p> <p>A09-73</p>	<p>2</p>  <p>A09-71</p> <p>A09-73</p> <p>A01</p>	<p>3</p>  <p>A01 back view</p> <p>Fold four sides to the middle</p>	<p>4</p>  <p>A01</p>	<p>5</p>  <p>plan view</p> <p>A05-01 A05-02 A05-03 A05-04 A05-05 A05-06 A05-07 A05-08 A05-09 A05-10 A05-11 A05-12 A05-13</p>	
<p>6</p>  <p>A02</p> <p>A05-01</p> <p>A05-02</p>	<p>7</p>  <p>A05-04 A05-03</p> <p>A02</p>	<p>8</p>  <p>A05-05 A05-06 A05-07 A05-08 A05-09 A05-10</p> <p>A02</p>	<p>9</p>  <p>A02</p> <p>A05-12 A05-11</p>	<p>10</p>  <p>A05-13 A05-13</p> <p>A02</p>	

<p>11</p>  <p>A02</p> <p>A09-86</p> <p>The red line is the part of the printed paper that needs to be pasted.</p>	<p>12</p>  <p>A02</p> <p>A09-87</p> <p>The red line is the part of the printed paper that needs to be pasted.</p>	<p>13</p>  <p>A09-88</p> <p>A02</p> <p>The red line is the part of the printed paper that needs to be pasted.</p>	<p>14</p>  <p>A02</p> <p>A09-89</p> <p>The red line is the part of the printed paper that needs to be pasted.</p>	<p>15</p>  <p>A02</p> <p>A09-91</p> <p>The red line is the part of the printed paper that needs to be pasted.</p>	<p>16</p>  <p>A02</p> <p>A09-92</p> <p>The red line is the part of the printed paper that needs to be pasted.</p>
<p>17</p>  <p>A09-94</p> <p>A02</p> <p>The red line is the part of the printed paper that needs to be pasted.</p>	<p>18</p>  <p>A02</p> <p>A09-95</p> <p>The red line is the part of the printed paper that needs to be pasted.</p>	<p>19</p>  <p>A09-102</p> <p>A02</p>	<p>20</p>  <p>granary</p> <p>armory</p>	<p>21</p>  <p>F01</p> <p>F02</p>	<p>22</p>  <p>F01</p> <p>F01</p> <p>make 2pieces</p>
<p>23</p>  <p>F01</p> <p>A02</p>	<p>24</p>  <p>A09-70</p> <p>B10</p>	<p>25</p>  <p>F01</p> <p>B10</p>	<p>26</p> <p>Please pay attention to the upper and lower sides of A08-06 when pasting.</p>  <p>light No.1</p> <p>A08-06 back view</p> <p>0.3cm</p> <p>0.3cm</p>	<p>27</p>  <p>A08-06</p> <p>B10</p>	<p>28</p>  <p>A02</p> <p>Paste the wiring of the lamp as shown in the figure and put the lamp wire into the A02 small hole.</p>
<p>29</p>  <p>light wire</p> <p>A02</p> <p>Centralize the light wire to A02 here</p>	<p>30</p>  <p>A08-09</p>	<p>31</p>  <p>weapon</p> <p>urnace</p>	<p>32</p>  <p>bow and arrow</p> <p>weapon rack</p>	<p>33</p>  <p>F01</p>	<p>34</p>  <p>F03</p> <p>A09-67</p>
<p>35</p>  <p>F03</p>	<p>36</p>  <p>A08-06</p>	<p>37</p>  <p>F13</p> <p>F13</p>	<p>38</p>  <p>F14</p>	<p>39</p>  <p>F04</p> <p>F04</p>	<p>40</p>  <p>F04</p> <p>F04</p> <p>make 2pieces</p>
<p>41</p>  <p>F04</p> <p>A02</p>	<p>42</p>  <p>A09-70</p> <p>B10</p>	<p>43</p>  <p>B10</p> <p>F04</p>	<p>44</p>  <p>A08-05</p> <p>A08-04</p> <p>A08-03</p> <p>A08-02</p> <p>A08-01</p>	<p>45</p>  <p>40</p>	<p>46</p>  <p>40</p> <p>40</p> <p>make 2pieces</p>

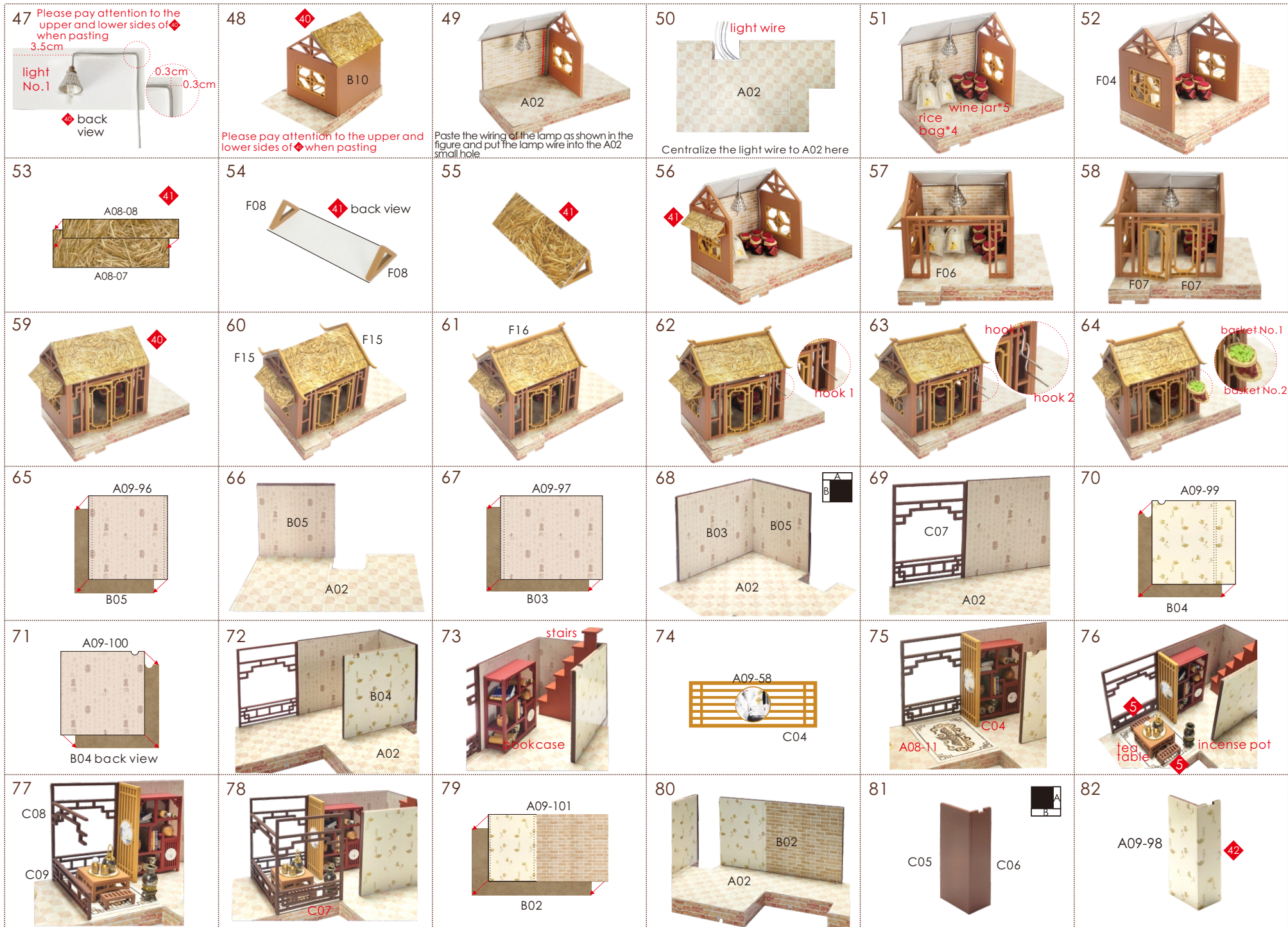

<p>83</p>	<p>84</p>	<p>85</p>	<p>86</p>	<p>87</p>	<p>88</p>
<p>89</p>	<p>90</p>	<p>91</p>	<p>92</p>	<p>93</p>	<p>94</p>
<p>95</p>	<p>96</p>	<p>99</p> <p>A03 back view</p> <p>light No.1</p> <p>light No.2</p> <p>light No.3</p>		<p>100</p> <p>light No.6</p> <p>A03</p> <p>Place the lamp wire of No.6 light into the small hole of A03.</p>	<p>101</p> <p>light No.6</p> <p>A03</p>
<p>97</p> <p>The red line is the part of the printed paper that needs to be pasted.</p> <p>A09-107</p> <p>A03</p>	<p>98</p> <p>A09-103</p> <p>A03</p>	<p>102</p> <p>No.1 and No.6 lights wired.</p> <p>A02</p>	<p>103</p> <p>A03</p> <p>Place the lights wires of lights No.1 and lights No.6 into the small hole of A02.</p>		
<p>104</p> <p>A09-74</p> <p>A09-75</p> <p>A09-77</p> <p>A09-80</p> <p>A09-78</p> <p>A09-79</p> <p>A09-76</p> <p>A09-81</p> <p>D01</p> <p>D02</p> <p>D03</p> <p>D04</p> <p>D05</p> <p>D06</p> <p>D07</p> <p>D08</p> <p>A03</p> <p>Plant view</p> <p>Please note A09-79 and A09-76 front and back</p>		<p>105</p> <p>D01</p> <p>D02</p> <p>D03</p> <p>D04</p> <p>D05</p> <p>D06</p> <p>D07</p> <p>D08</p> <p>A03</p>	<p>106</p> <p>D09</p> <p>D09</p> <p>A03</p> <p>Affix D09 to the joint of every two boards.</p>		



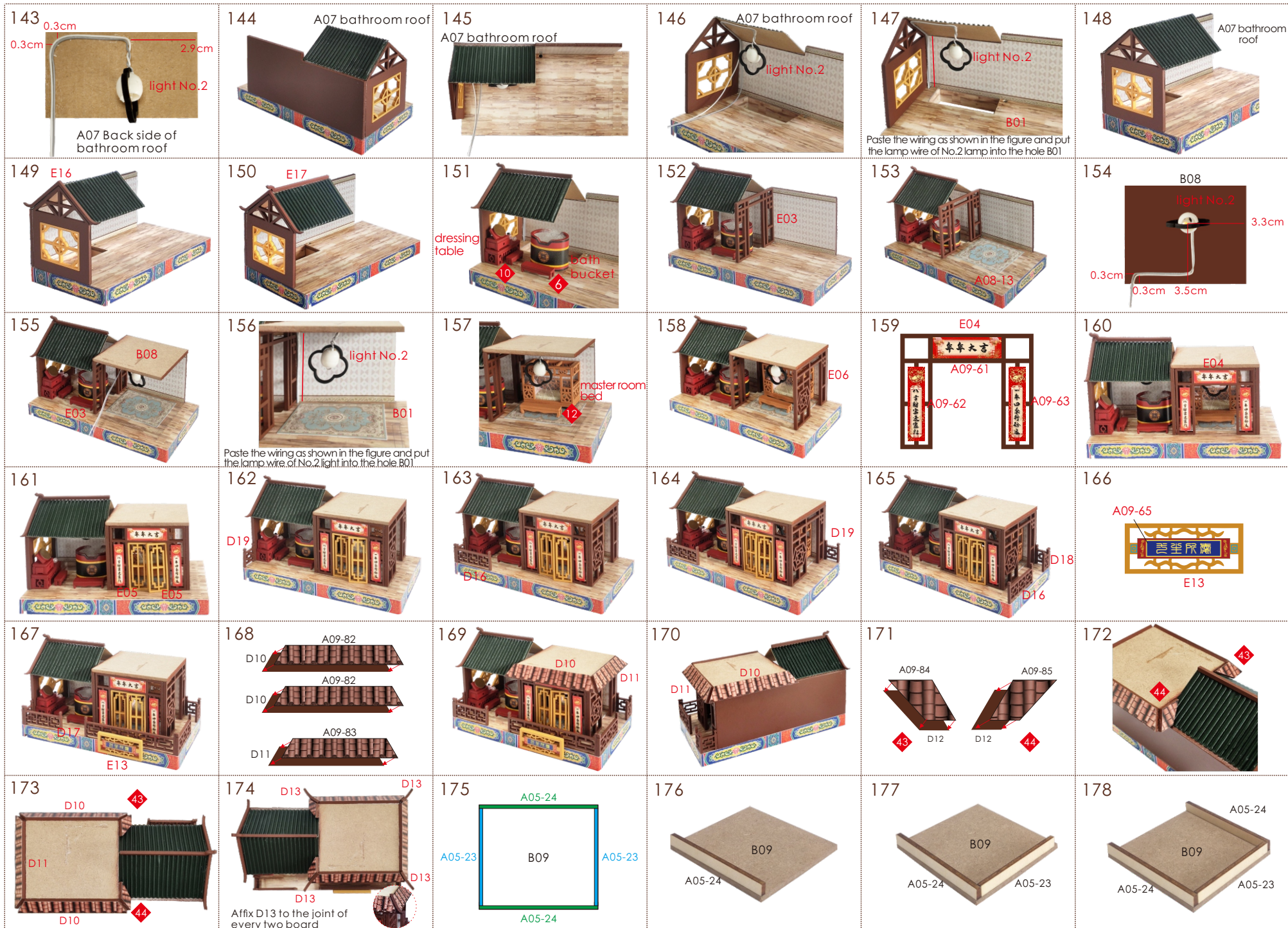

<p>179</p> <p>A05-23 A05-24</p>  <p>B09</p> <p>A05-24 A05-23</p>	<p>180</p> <p>A05-22</p>  <p>B09</p> <p>A05-22</p>	<p>181</p> <p>A05-22</p>  <p>B09</p> <p>A05-22</p>	<p>182</p> <p>A09-109</p>  <p>B09</p> <p>A09-109 A09-110</p>	<p>183</p> <p>A09-109 A09-110</p>  <p>B09</p> <p>A09-109 A09-110</p>	<p>184</p> <p>Note A07 stripe direction</p>  <p>A07 master bedroom roof A07 master bedroom roof</p> <p>Please cut out A07 according to the template paper.</p>
<p>185</p> <p>A07 master bedroom roof</p> 	<p>186</p> <p>A07 master bedroom roof</p> 	<p>187</p> <p>E18</p> 	<p>188</p> <p>E19</p> 	<p>189</p> 	<p>190</p>  <p>A03</p> <p>Put the light wire into the A03 hole as shown in the figure.</p>
<p>191</p> 	<p>192</p> <p>D14</p>  <p>D14</p>	<p>193</p> <p>D14 D15</p>  <p>D14 D15</p>	<p>194</p> <p>chime</p>  <p>chime</p>	<p>195</p> 	
<p>196</p> <p>6.5cm 10cm 5.5cm</p> <p>A01</p> <p>9cm W02</p> <p>W02</p> <p>city wall</p>  <p>Paste the lamp line of the city wall as shown in the figure.</p>	<p>197</p> <p>P12</p>  <p>P12</p>	<p>198</p> <p>S01</p>  <p>S01</p>	<p>199</p> <p>W02</p>  <p>W02</p>	<p>200</p> <p>watchtower No.1</p> <p>Place W02 on watchtower No.1</p> <p>W02</p>  <p>W02</p>	
<p>201</p> <p>A09-64</p> <p>古城镇</p> <p>S02</p>  <p>S02</p>	<p>202</p> <p>S02 S03</p>  <p>S02 S03</p>	<p>203</p> <p>watchtower No.2</p>  <p>watchtower No.2</p>	<p>204</p> <p>3.7cm 3.3cm</p> <p>watchtower No.2</p> <p>Paste the wiring of No.2 watchtower light wire as shown in the figures.</p>  <p>watchtower No.2</p>	<p>205</p> <p>S01</p>  <p>S01</p>	

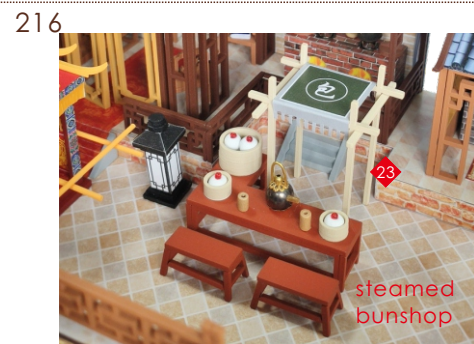
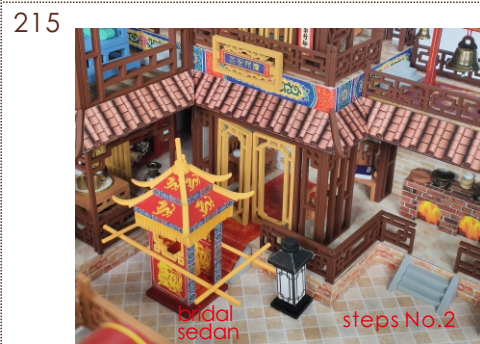

How to assemble the battery holder

Statement: the lamp wires cannot be inserted into the output socket.

- Can use 2*AAA batteries
- Please notice the place of anode and cathode when put in the batteries
- Rechargeable batteries are not blunt electricity
- Rechargeable batteries can only be charged under adult supervision
- Rechargeable batteries should be removed from the toy before charging
- Different types of batteries cannot mix; Do not mix new batteries in use with semi-used batteries.
- Run out of battery should be removed from the toy
- The power shall not be short circuit

1

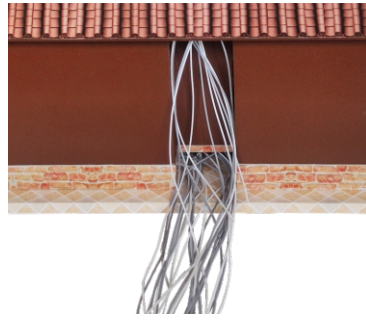

Concentrate all the light wires to the back

2

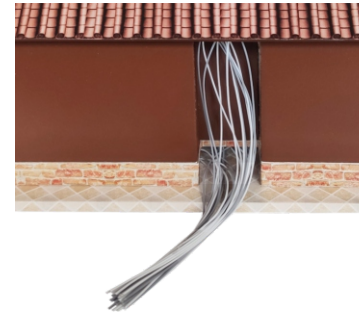

cut all the LED light wires to the same length

3

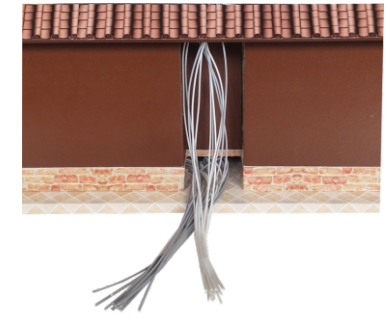

Distinguish the light lines of the same color

4



peel off the film of the LED light wires

5



Twist the light wires together

6

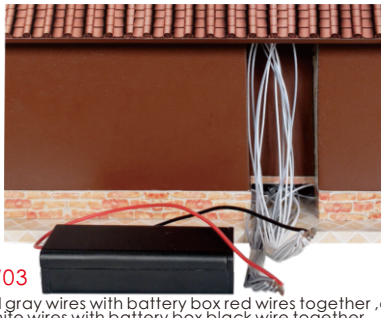

W03
Put all gray wires with battery box red wires together, and put all white wires with battery box black wire together. Wrap the bare wires with adhesive tape P04. Make sure the LED lights are on.

7

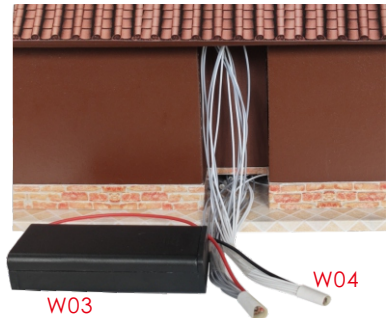

W03
W04
Wrap the light wire connection with W04.

8



Tuck in the light cord.

9



Put the battery compartment in.

Installation of dust cover

dust cover
(Upgrade version accessories need to be purchased separately)



scale:1:12
Z04 plexiglass(transparent)
35.8*29.2*0.18(1 piece)

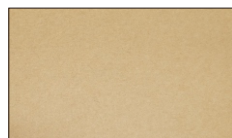

scale:1:12
Z05 plexiglass(transparent)
35.8*21*0.18(2 pieces)

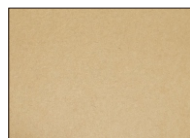

scale:1:12
Z06 plexiglass(transparent)
28.84*21*0.18(2 pieces)

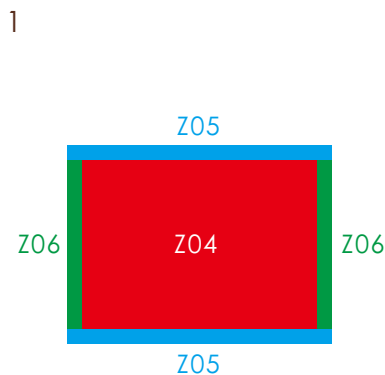

stick Z05 and Z06 on Z04.

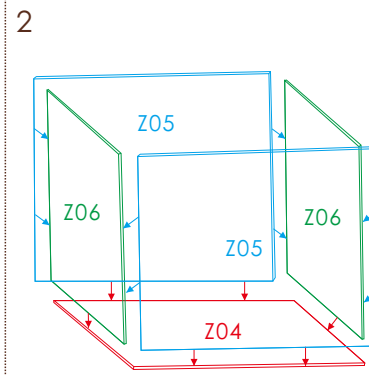

stick five pieces of plexiglass dust cover as shown



Take out the plexiglass and tear off the kraft paper with text on each piece of plexiglass

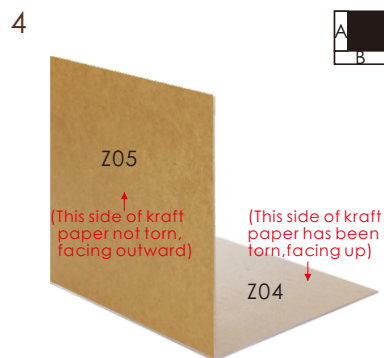

The kraft paper that has been ripped off faces inwards, and the kraft paper that has not been ripped out faces outwards.

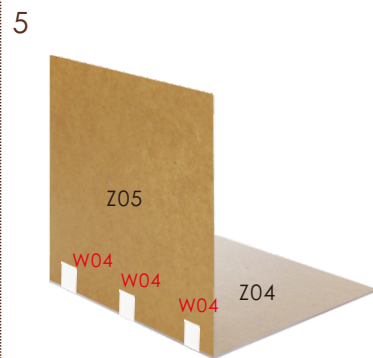

Use W04 to fix the junction of two pieces of plexiglass. (use transparent tape to replace W04)

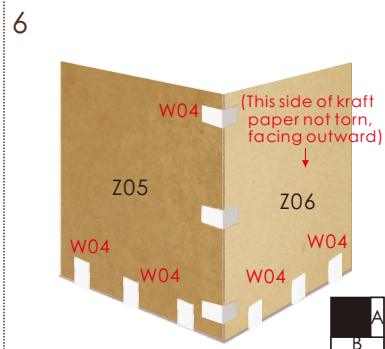

The junction of every two pieces of plexiglass needs to be fixed with P04 (to prevent the plexiglass falling off)

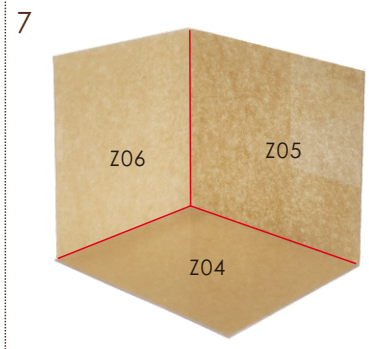

stick appropriate amount of glue to the interface of the two pieces of glass and scrape it slightly to make the glue penetrate into the junction of the two pieces of glass (the red line is the plexiglass interface)

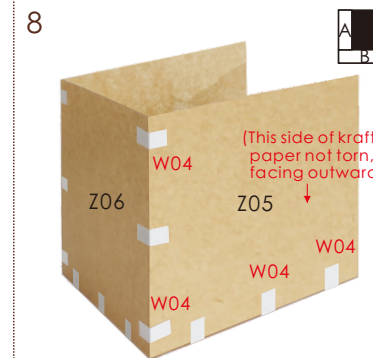

The junction of two pieces of plexiglass needs to be fixed with W04 (to prevent the plexiglass falling off)

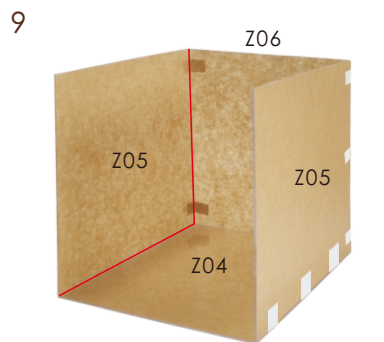

stick appropriate amount of glue to the interface of the two pieces of glass and scrape it slightly to make the glue penetrate into the junction of the two pieces of glass (the red line is the plexiglass interface)

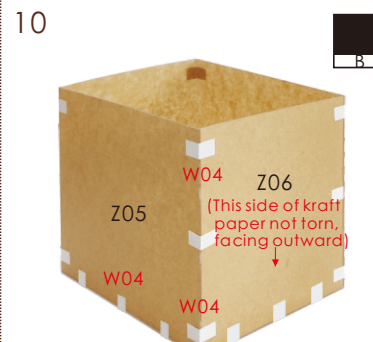

The junction of two pieces of plexiglass needs to be fixed with W04 (to prevent the plexiglass falling off)

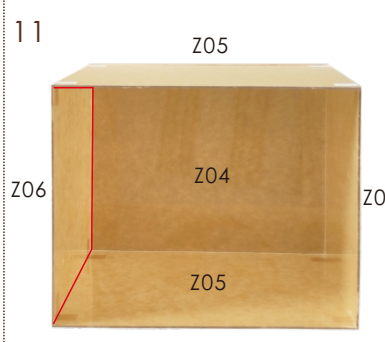

stick appropriate amount of glue to the interface of the two pieces of glass and scrape it slightly to make the glue penetrate into the junction of the two pieces of glass (the red line is the plexiglass interface)

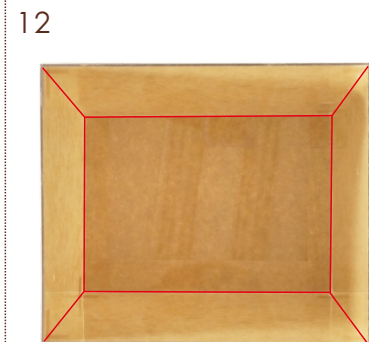

the dust cover need to be glued 8 interfaces

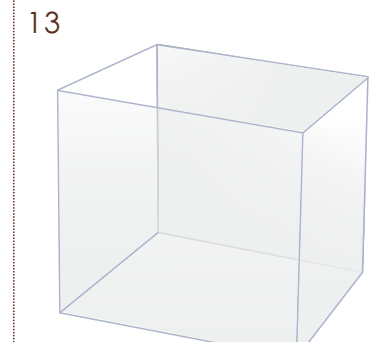

Leave it for 1 hour. After the glue dries out, tear off a layer of kraft paper outside the plexiglass

Detail Appreciation



With dust cover at night

The instruction manual should be keep, after assembled