

# Fairy Castle

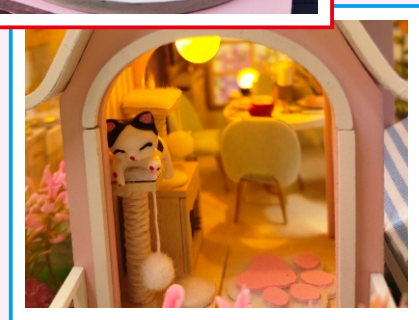

# NOTICE OF ASSEMBLE

## Tips for assembling

1. Because this product contains small parts, children need to use this product with an adult to avoid accidental ingestion and cause suffocation hazard. There are sharp objects in the product, be careful not to pierce people to avoid injury.
2. After all the materials are used in the required amount in the operation steps, put the remaining materials back into the original bag until the installation is completed. (Avoid losing materials during the installation process)
3. The unit of dimension marked in the step diagram is "cm".
4. Tips for making template paper: Put the template on the back of the material, fix it with some small double-sided tape, and then cut out the material to prevent the cloth or template from moving in the cutting process, or causing errors in the cut material. Or lead to insufficient materials.
5. According to the "Parts Rule Example" at the bottom of this page, refer to the parts on the part number drawing, find the actual product and compare it with the bill of materials, and then install it after confirming that it is correct. (Wooden parts only)
6. It is not advisable to apply too much glue, so as not to wait for a longer time to dry, and overflow will affect the effect of the finished product.
7. There are unavoidable small deviations in the color of wood, fabric, and beads of different batches, without notice, thanks for understanding.

## Tips for Assembling Wood



Find the corresponding block number, use a knife in the connection point gently press, you can take out the wood.

Use a knife to smooth out the burr.

Or use sandpaper to smooth out the burr

## Testing on LED function

Be sure to test the LED lights before making the lighting, note that the LED white wire to the negative, gray wire to the positive reference to the following figure operation test.

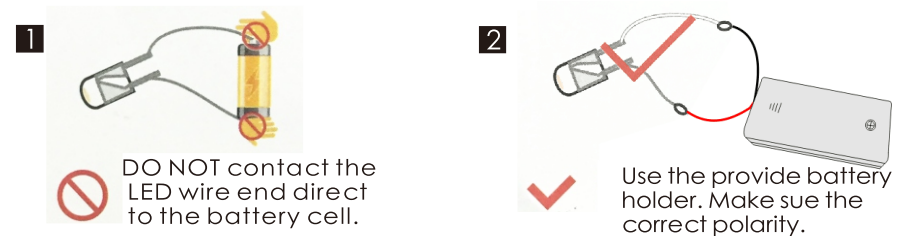

1 DO NOT contact the LED wire end direct to the battery cell.

2 Use the provide battery holder. Make sue the correct polarity.

## How to assemble the battery holder

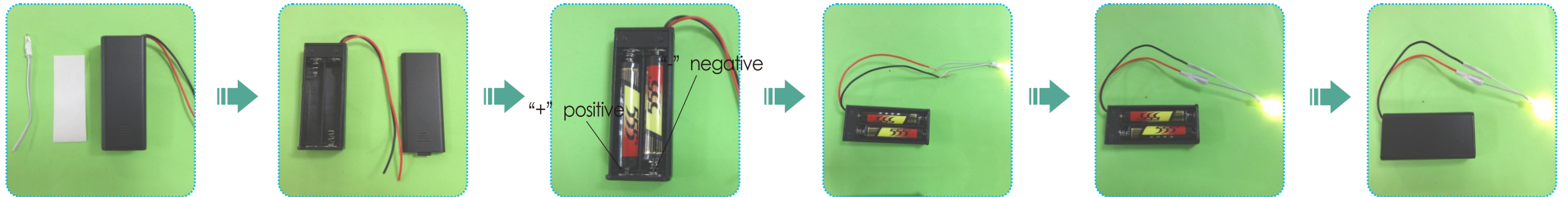

1. Material and tools needed:  
- Battery holder, LED bulb, tape, screw driver and 2 pieces AAA size battery(not provided)

2. Use screw driver and take the lid off from the battery holder.

3. Insert the battery take notes on the polarity.

4. Connect the red wire to grey wire. Connect the black wire to white wire.

5. Wrap the exposed wire with the tapes.

6. Place the box lid and fastness with screw driver.

## Examples of parts rule:

A01: The parts are directly in the box; B01: The parts are in the B bag; C01: The parts are in the C bag, and so on (Note: The printing paper is displayed in the step A31-1: The printing paper is placed directly in the box, The part number is A31-1. In the step, the template paper A31-N01 is displayed, A31 is the template paper, N01 is the cutting template used for the corresponding material, N01-1, N01-2 are the part numbers for the parts, and the printing paper and template paper are directly placed in the packaging box.)

# Catalog

Name of accessories	Related materials bags	
Printing paper & Template paper	A30, A31 of bag A (All printing paper and template paper are concentrated on A30, total 2 sheets of A3 single-sided printing paper and 2 sheets of A4 single-sided template paper)	
Lifebuoy	Bag G+Bag P+printing paper	Page 3
Seesaw	Bag G	Page 3
Rocking horse	Bag G+Bag Q+printing paper	Page 3
Swing	Bag G+Bag N+printing paper+template paper	Page 4
Outdoor Light	Bag G	Page 4
Coffee cup	Bag Q+printing paper	Page 4
Cat climbing frame	Bag H+Bag N+Bag Q+template paper	Page 5
Dining chair	Bag A+Bag N+Bag P+template paper	Page 5
Children dining chair	Bag A+Bag H+Bag N+template paper	Page 6
Dish	Bag P+Bag R+printing paper	Page 6
Round table	Bag A+Bag N+printing paper+template paper	Page 6
Potted plants	Bag N+Bag P+Bag Q+Bag R+printing paper+template paper	Page 7
Candle	Bag P+Bag Q+printing paper	Page 7
Screen	Bag A+Bag H+template paper	Page 7
Wall cabinet	Bag A+Bag J+Bag Q+printing paper	Page 8
Cooktop	Bag A+Bag J+Bag N+Bag P+Bag Q+printing paper+template paper	Page 8,9
wind vane	Bag A+Bag J+printing paper	Page 9
Hanging pictures	Bag A+printing paper	Page 9
Fireplace	Bag K+printing paper	Page 10
Light	Bag A+Bag N+Bag P+Bag S+template paper	Page 10
Coffee table	Bag A+Bag N+printing paper+template paper	Page 10,11
Sofa	Bag A+Bag N+Bag P+template paper	Page 11,12
Double bed	Bag A+Bag K+Bag N+printing paper+template paper	Page 12,13
Cabinet	Bag K+Bag P+Bag Q+Bag R	Page 13
Parachute	Bag L+Bag P+Bag Q+printing paper+template paper	Page 13,14
Rocking chair	Bag L+Bag N+Bag Q+template paper	Page 14
Bed end stool	Bag A+Bag L+Bag N+template paper	Page 14,15
Bed	Bag A+Bag L+Bag N+printing paper+template paper	Page 15,16
Piano	Bag A+Bag L+Bag N+Bag Q+printing paper+template paper	Page 16
Tub	Bag A+Bag M+Bag N+printing paper+template paper	Page 17
Bathroom cabinet	Bag M+Bag P+Bag Q+printing paper	Page 17
Plant 2	Bag N+Bag P+Bag R+template paper	Page 17

Name of accessories	Related materials bags	
Drum kit	Bag M+Bag N+template paper	Page 18
Drumsticks	Bag A+Bag Q+printing paper	Page 18
Telescope	Bag P+Bag Q+printing paper	Page 18,19
Fan Chandelier	Bag N+Bag P+printing paper+template paper	Page 19
Large chandelier	Bag A+Bag N+Bag P+Bag S+template paper	Page 19
Balloon	Bag P+Bag Q+Bag R	Page 19
Slide	Bag F+printing paper	Page 20
Steps 1,2	Bag A+Bag F+printing paper	Page 20
Television	Bag K+printing paper	Page 20
City gate	Bag F+printing paper	Page 20-21
Bathroom divider	Bag A+Bag P+printing paper+template paper	Page 21
Cat carpet	Bag N+template paper	Page 21
Doghouse	Bag A+Bag N+Bag Q+printing paper+template paper	Page 22
Slippers	Bag A+Bag N+template paper	Page 22
Curtain	Bag N+Bag P+Bag Q+template paper	Page 22
Toilet	Bag N+Bag Q+template paper	Page 22
Plant	Bag P+Bag Q+printing paper	Page 23
Sunflower	Bag N+Bag P+Bag Q+Bag R+template paper	Page 23
Paper lowers	Bag N+Bag Q+template paper	Page 23
Third floor roof	Bag A+Bag D+Bag E+Bag N+Bag P+printing paper+template paper	Page 23
Elevator	Bag A+Bag E+printing paper+template paper	Page 24
Elevator roof	Bag A+Bag E+Bag Q+printing paper	Page 24
Elevator bracket	Bag A+Bag E+printing paper+template paper	Page 25
Third floor	Bag A+Bag D+Bag E+Bag N+printing paper+template paper	Page 26
Piano room	Bag A+Bag D+Bag N+Bag P+printing paper+template paper	Page 26,27
Kitchen floor	Bag A+printing paper	Page 27
Daylighting windows of third floor	Bag A+Bag D+template paper	Page 28
Balcony 1,2,3	Bag A+Bag C+template paper	Page 28
Children room	Bag A+Bag B+Bag N+printing paper+template paper	Page 28,29
Pet room	Bag A+Bag B+Bag N+printing paper+template paper	Page 29
Chandelier of first floor	Bag K+Bag N+Bag P+template paper	Page 30
Outer frame	Bag A+Bag B+Bag C+Bag D+Bag N+Bag P+Bag R+printing paper+template paper	Page 30-38
Battery box	Bag S	Page 38

## Thumbnail of material list (reference only)



## Thumbnail of printing paper & template paper (reference only)

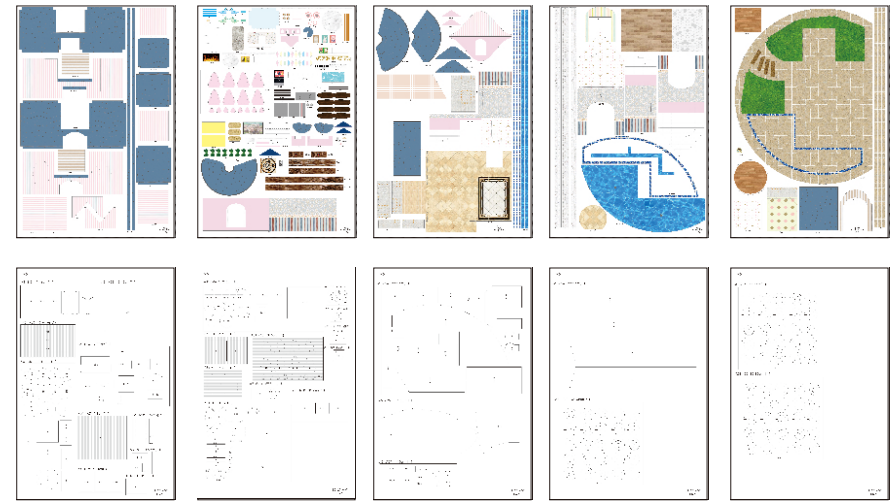

## Symbol description used

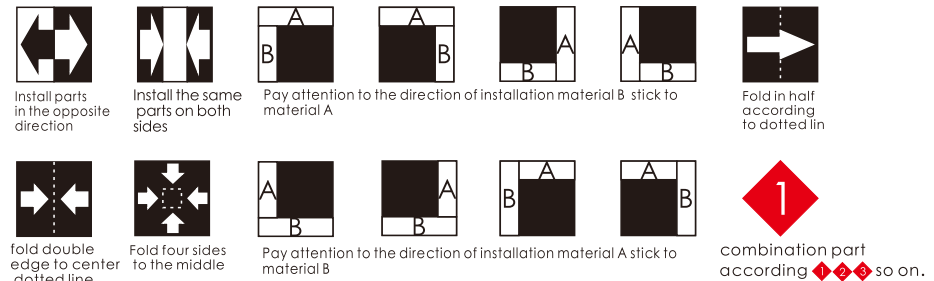

Lifebuy

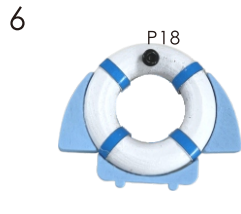
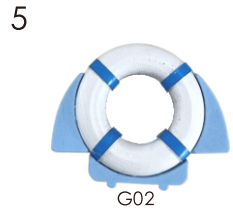
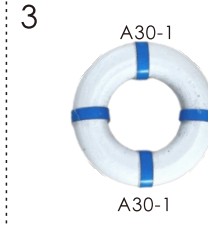
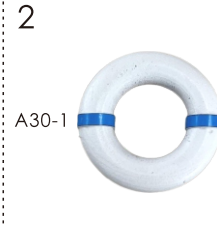
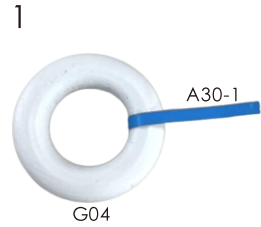
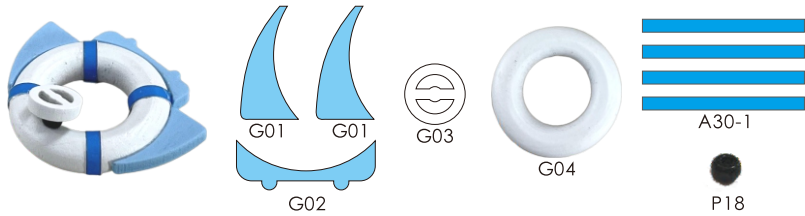

Seesaw

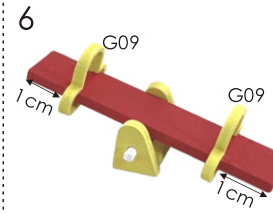
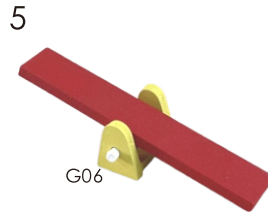
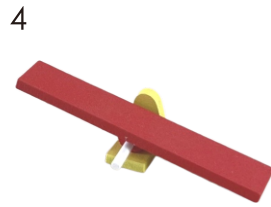
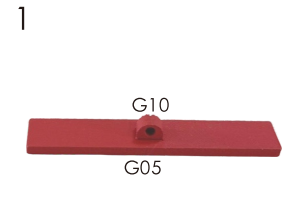
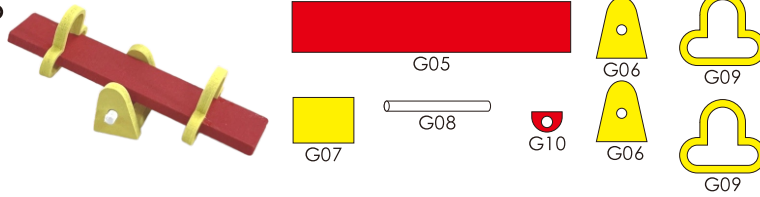

Rocking horse

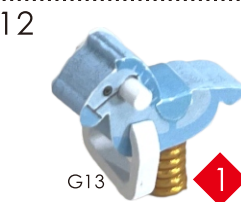
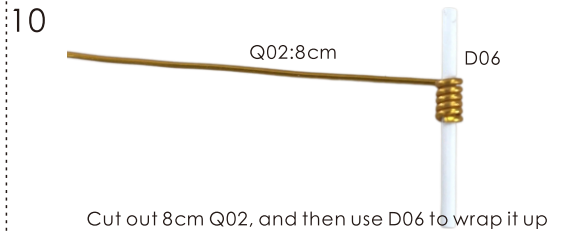
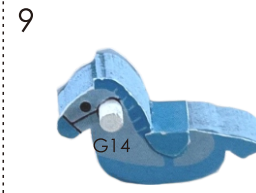
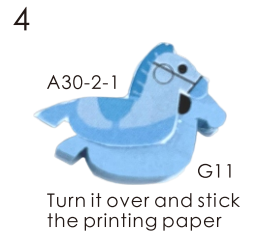
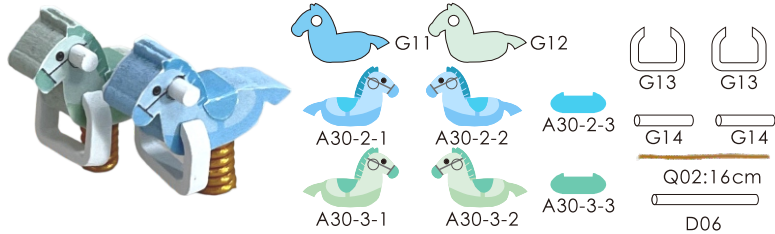

Swing

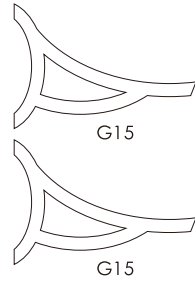

Cut out A27, N04 and N06 according to the template before making

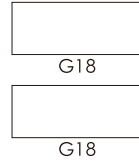
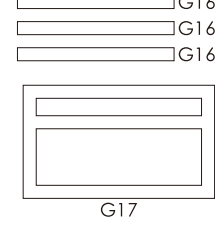

Q06:18cm

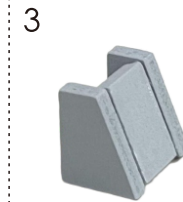
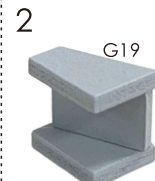
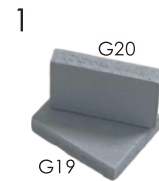
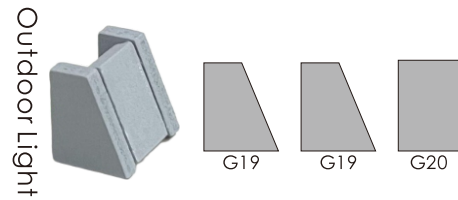
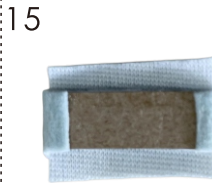
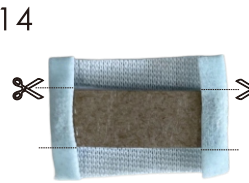
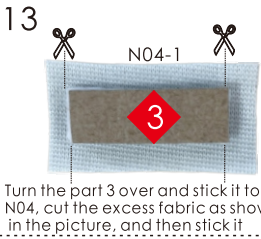
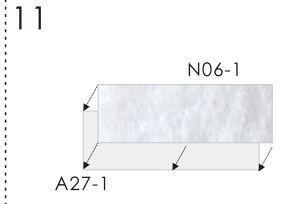
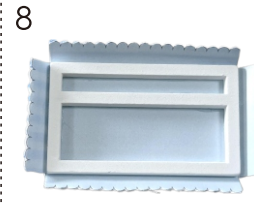
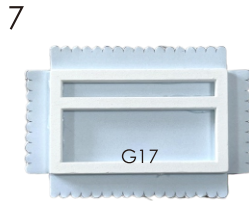
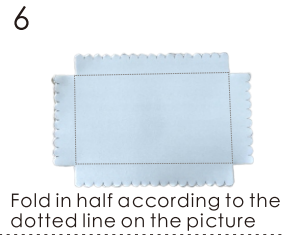
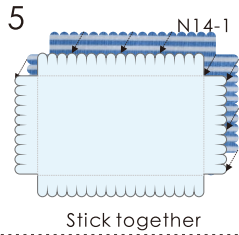
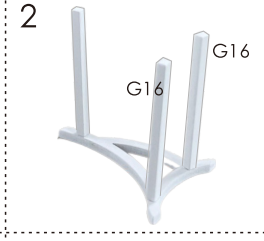
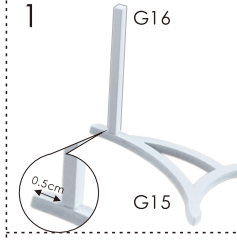
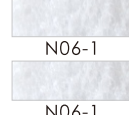
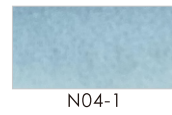
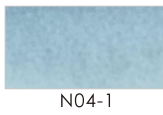
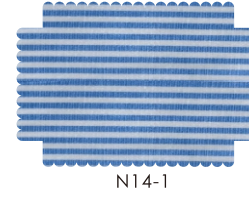
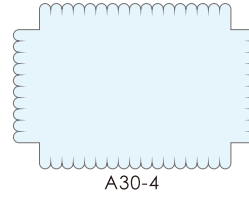

Coffee cup



Stick the printing paper inside the coffee cup

Cat climbing frame

Cut out N06 according to the template before making

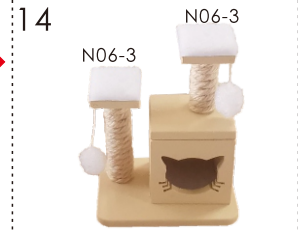
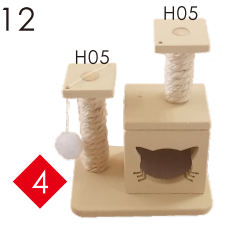
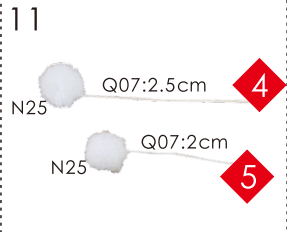
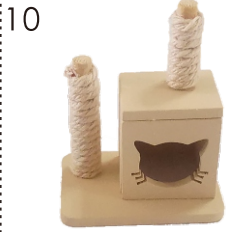
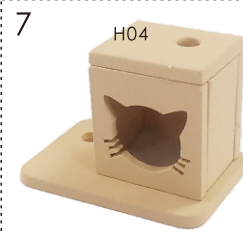
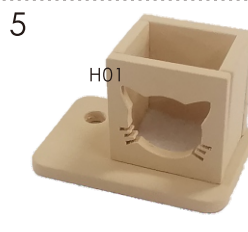
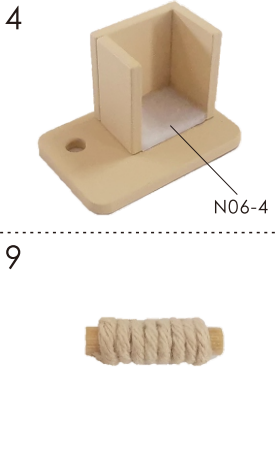
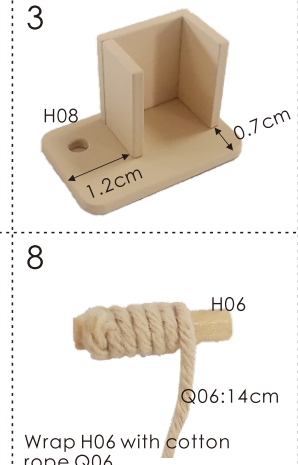
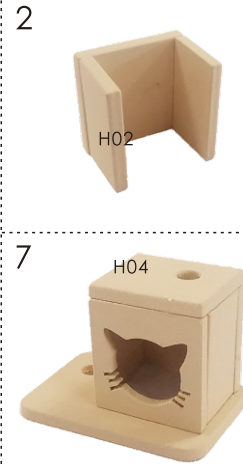
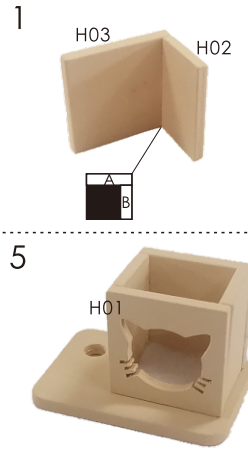
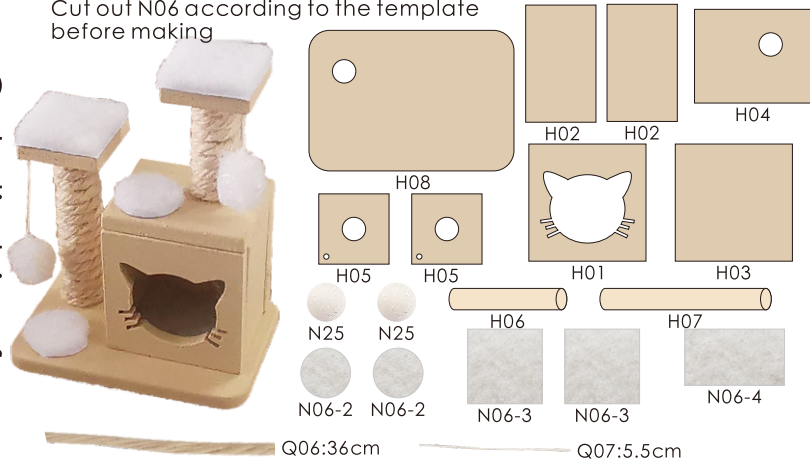

Cut out N04 and N06 according to the template before making

Dining chair

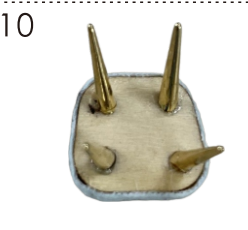
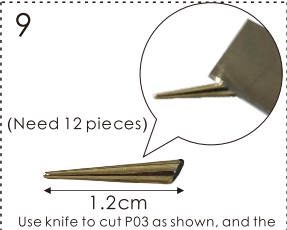
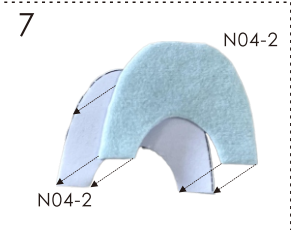
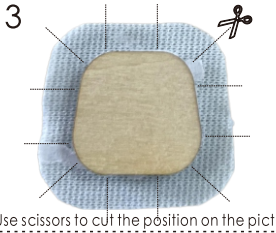
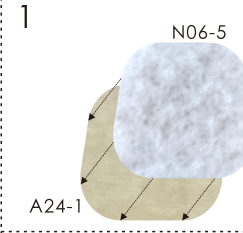
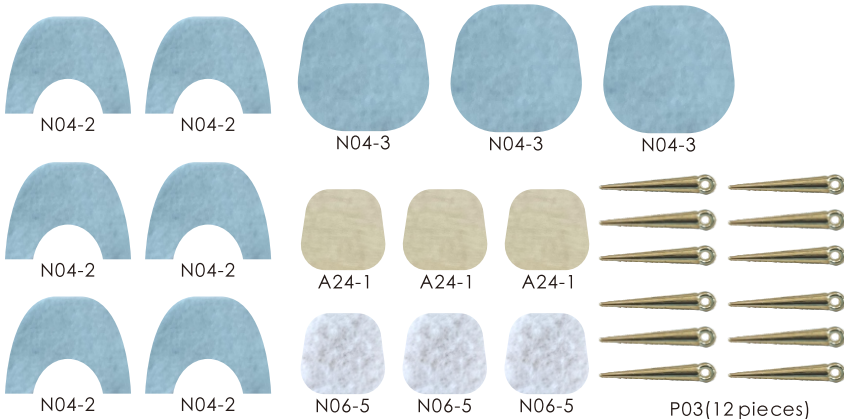

Children dining chair

Cut out N04 and N06 according to the template before making

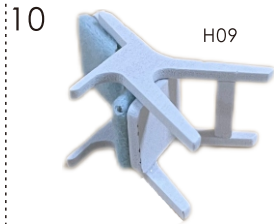
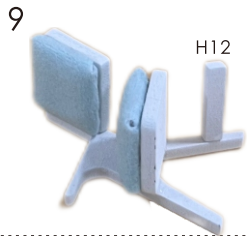
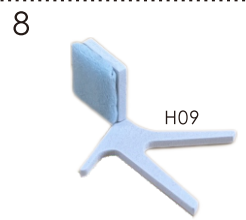
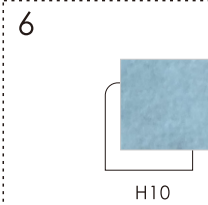
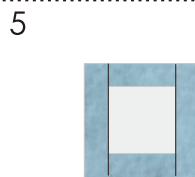
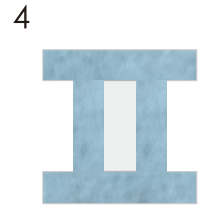
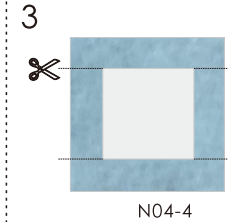
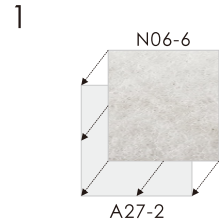
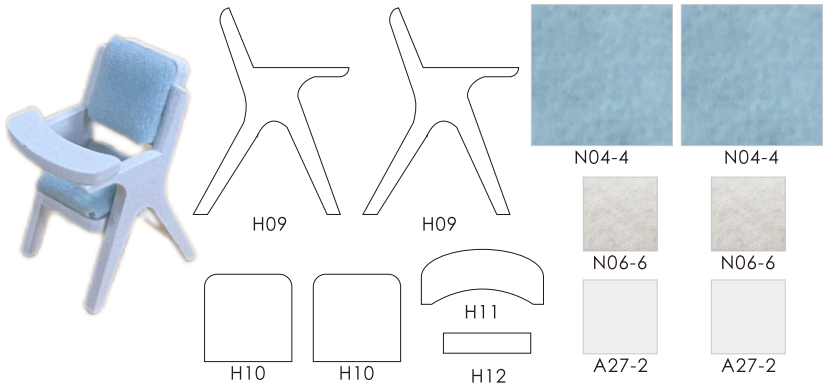

Dish

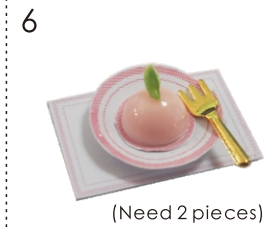
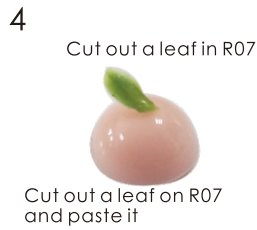
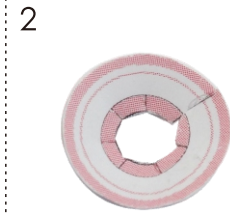
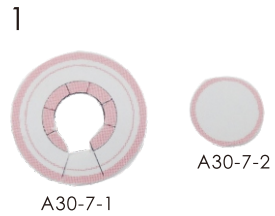
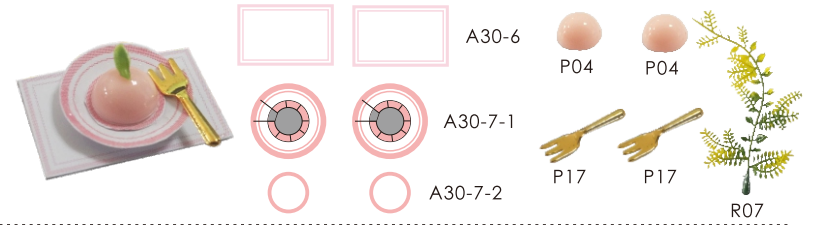

Round table

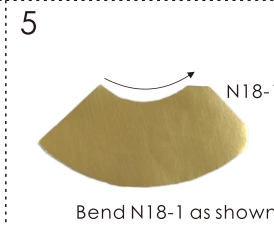
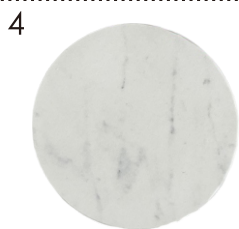
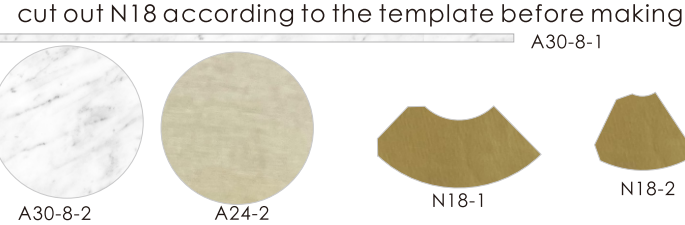

Potted plants

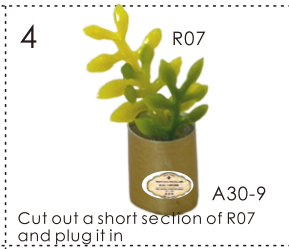
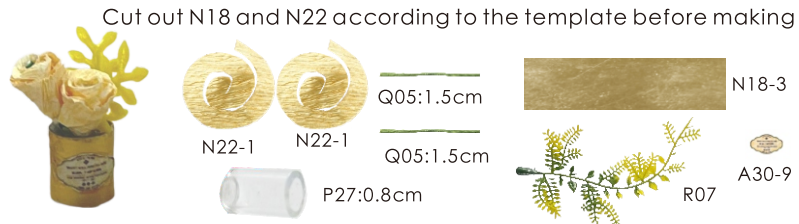

Paper flowers



Candle

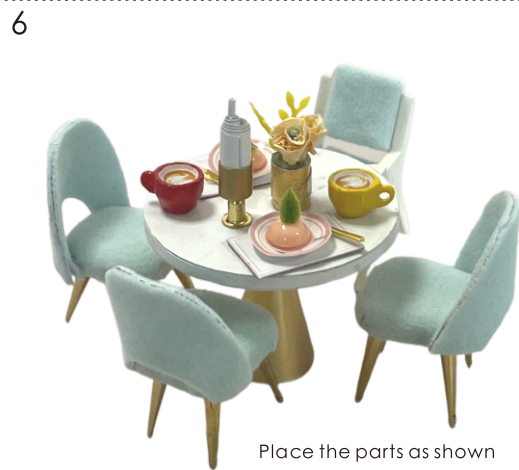
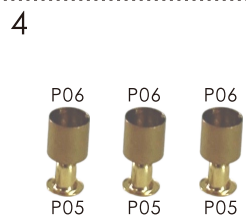
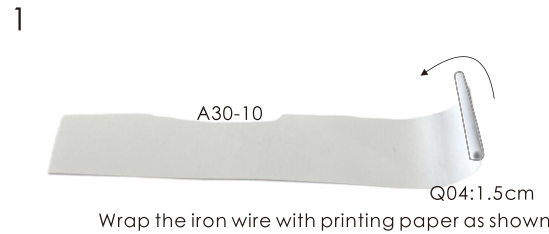
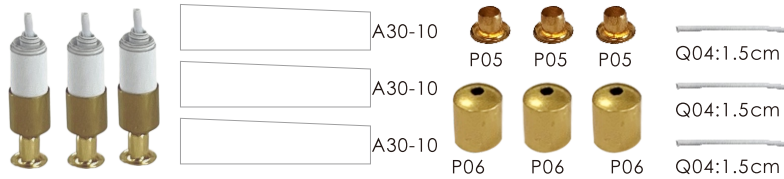

Cut out N26 according to the template before making

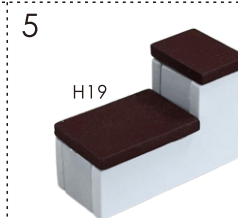
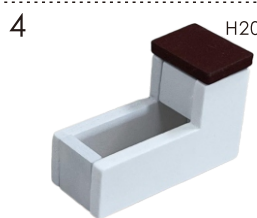
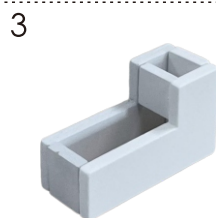
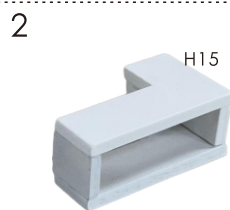
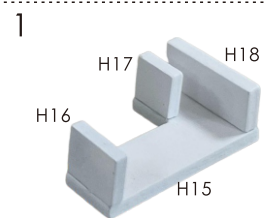
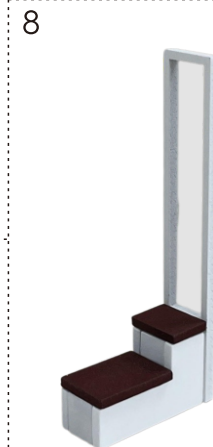
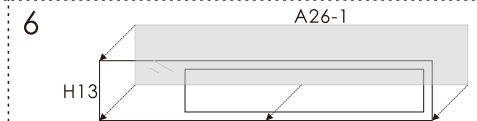
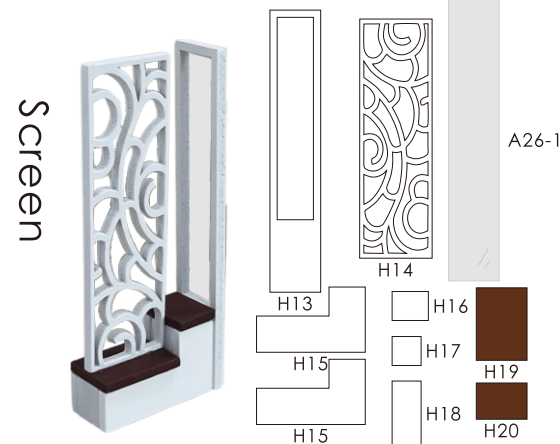



Wall cabinet

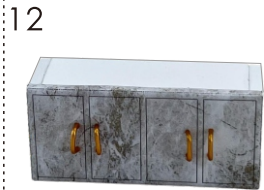
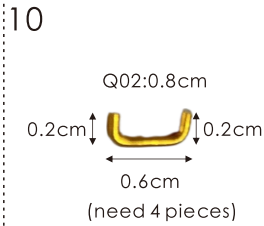
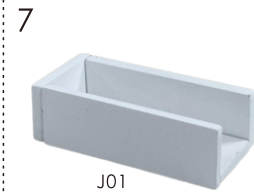
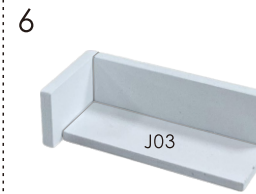
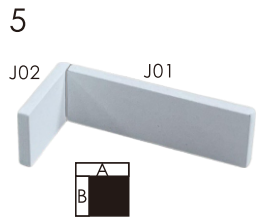
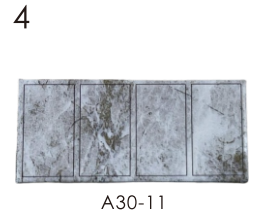
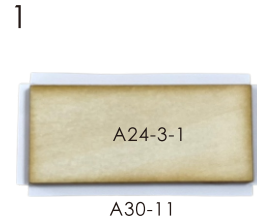
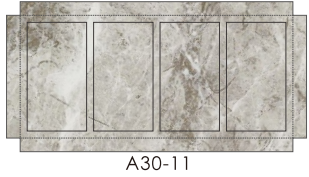
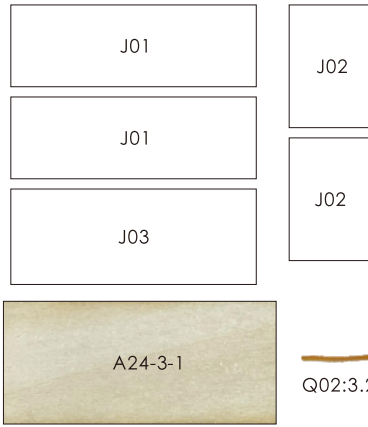

Cooktop



Cut out N19 according to the template before making

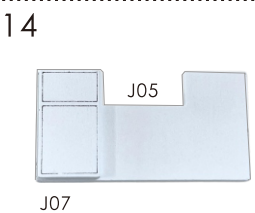
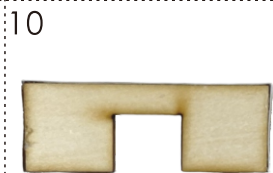
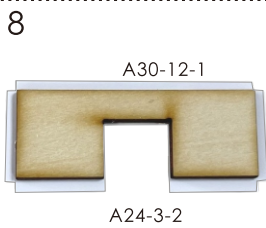
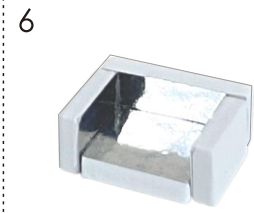
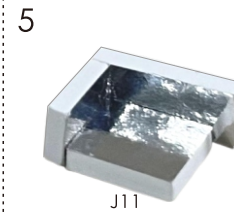
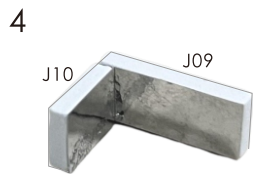
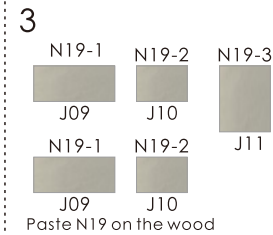
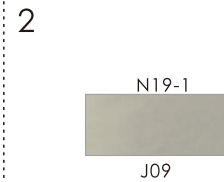
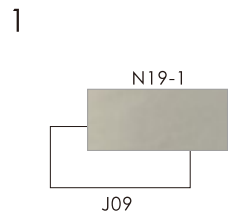
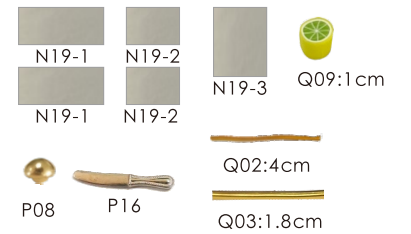
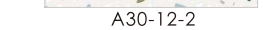
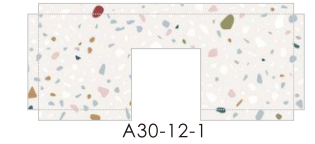
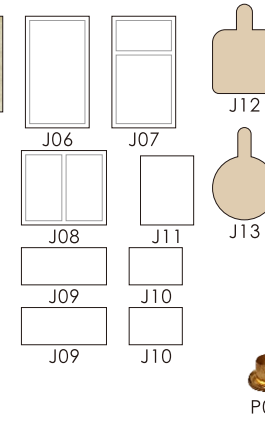
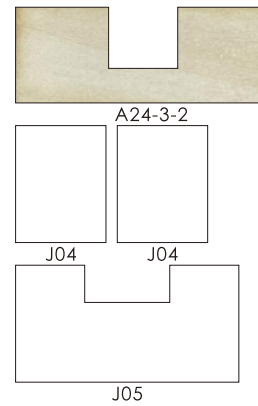



Wind vane

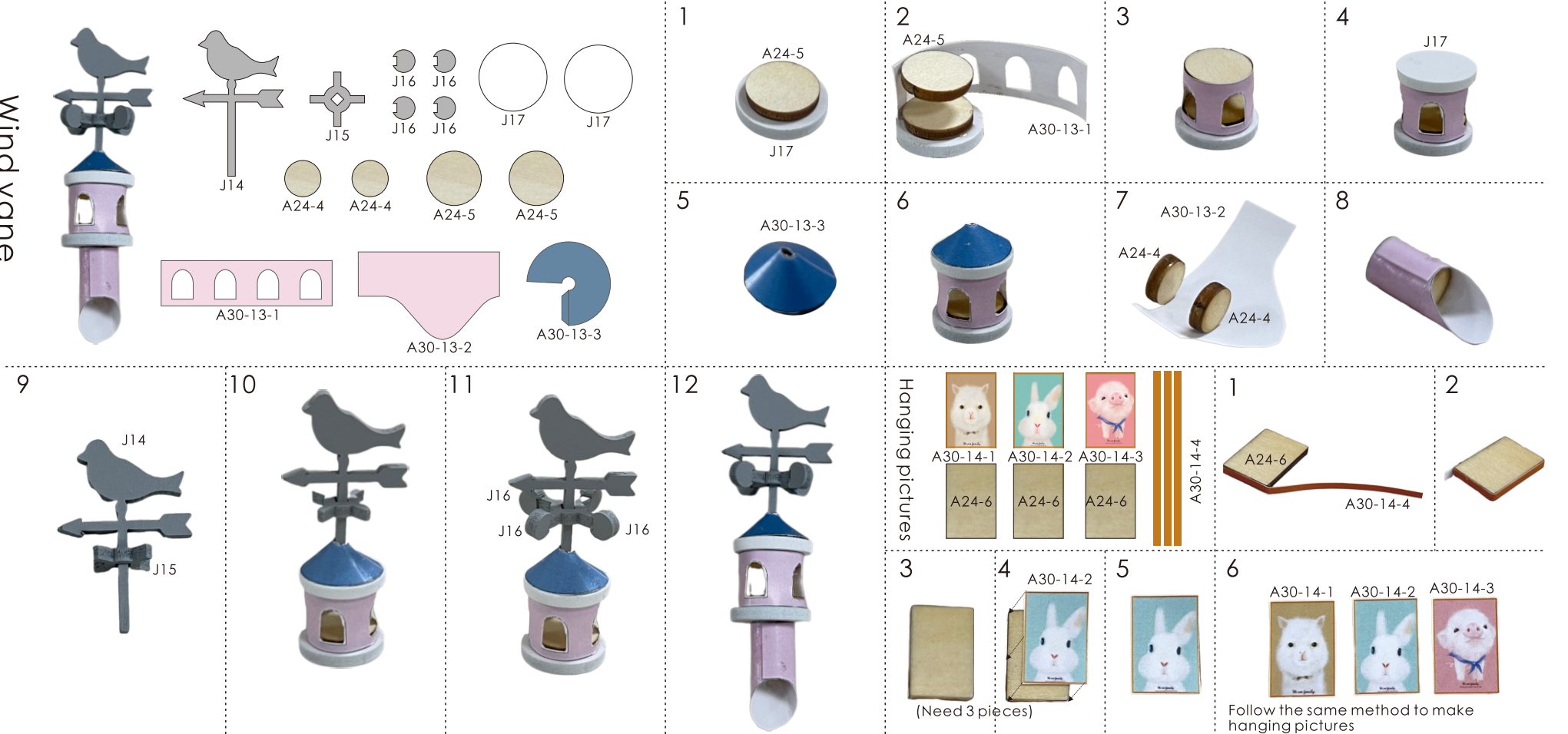

Fireplace

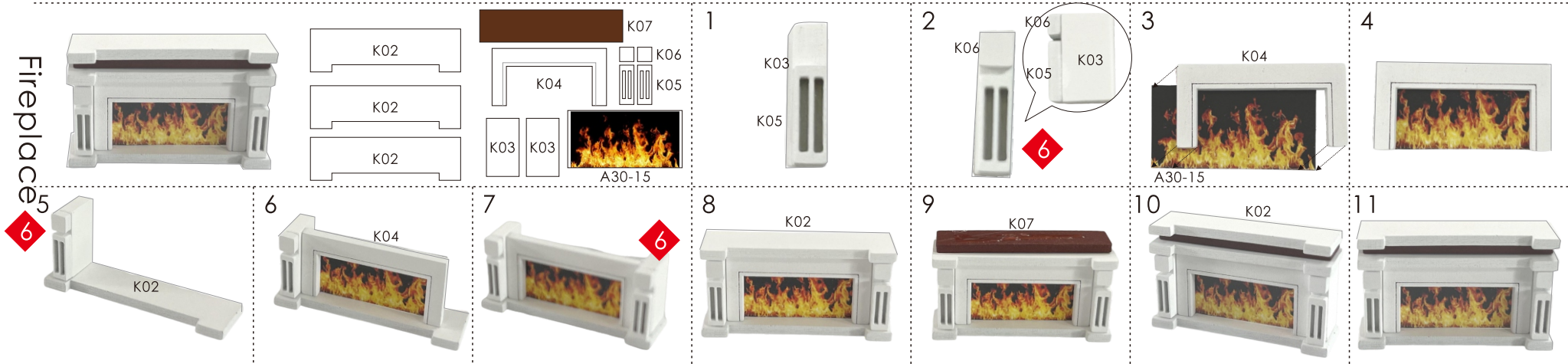

Cut out N18 according to the template before making

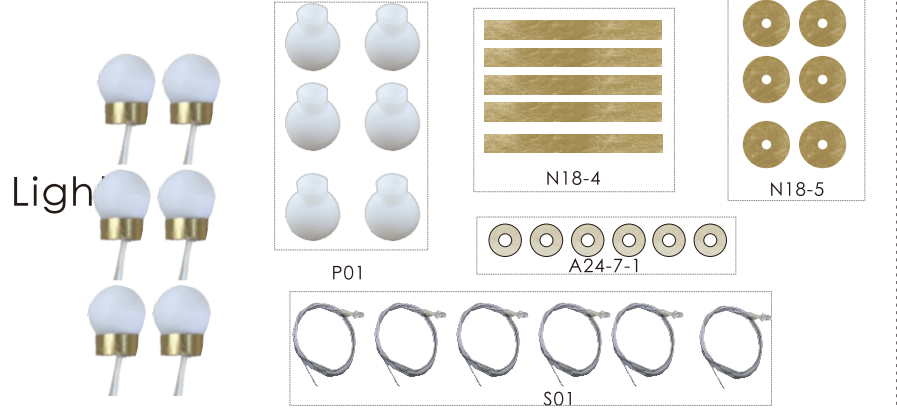

Lamp

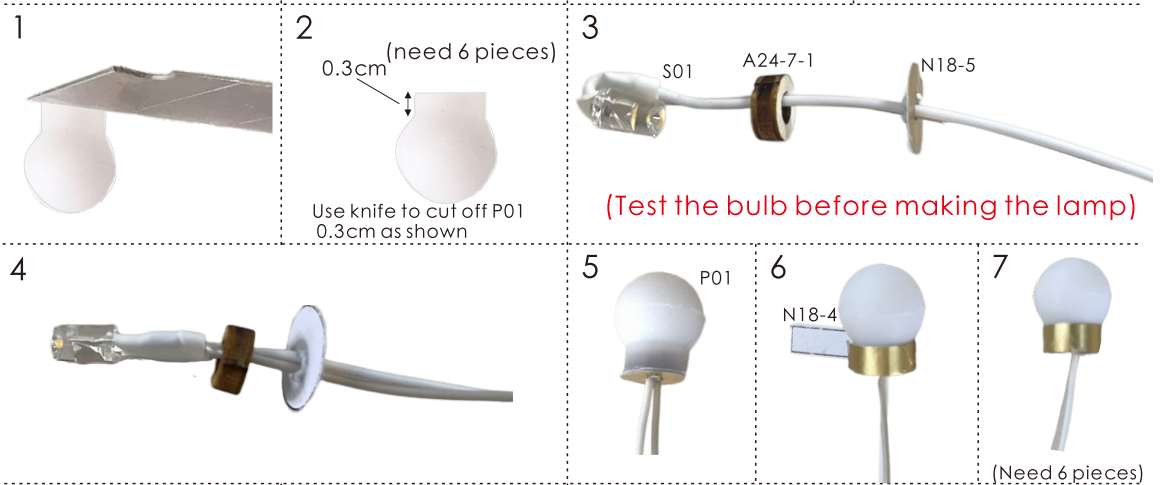

(Test the bulb before making the lamp)

Cut out N18 according to the template before making



Coffee table

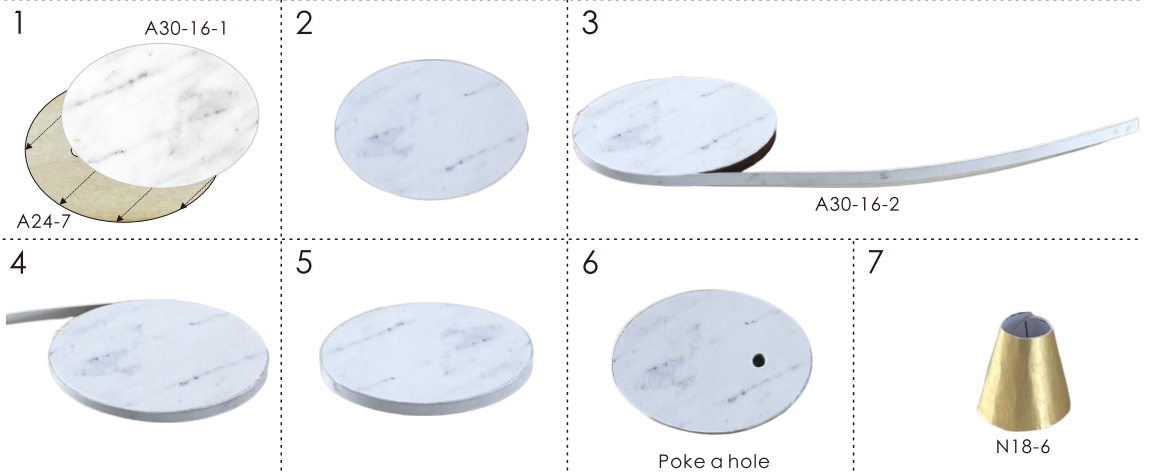

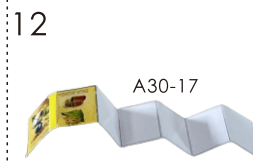
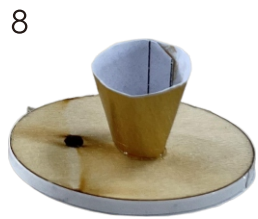

Cut out N05 and N06 according to the template before making



P10(5 pieces)

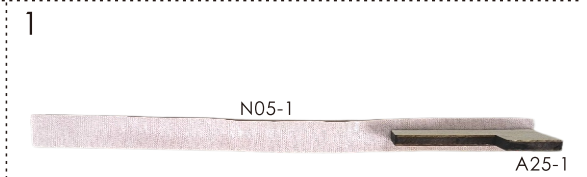
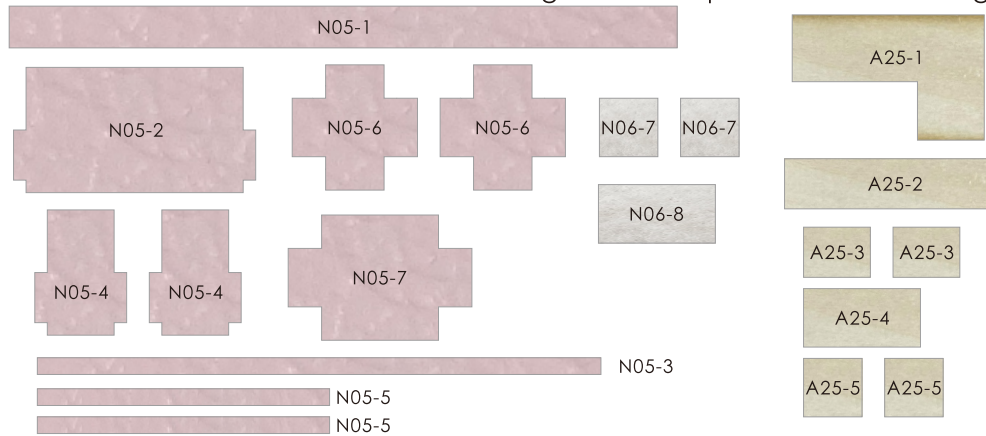

Stick A25-1 to N05-1 as shown

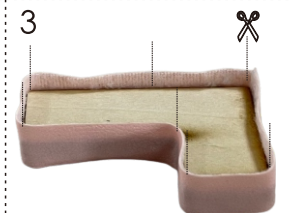

Cut the leather as shown

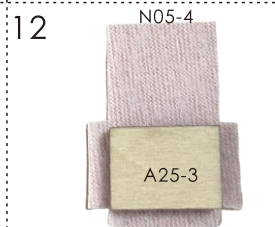
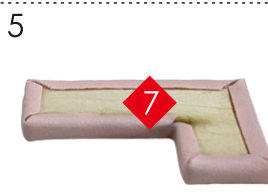

(Need 2 pieces)

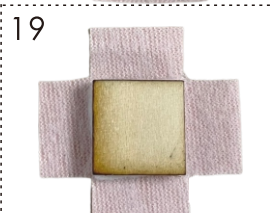
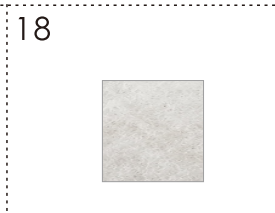
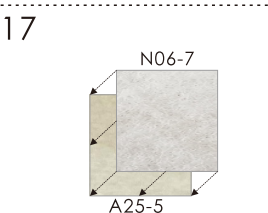

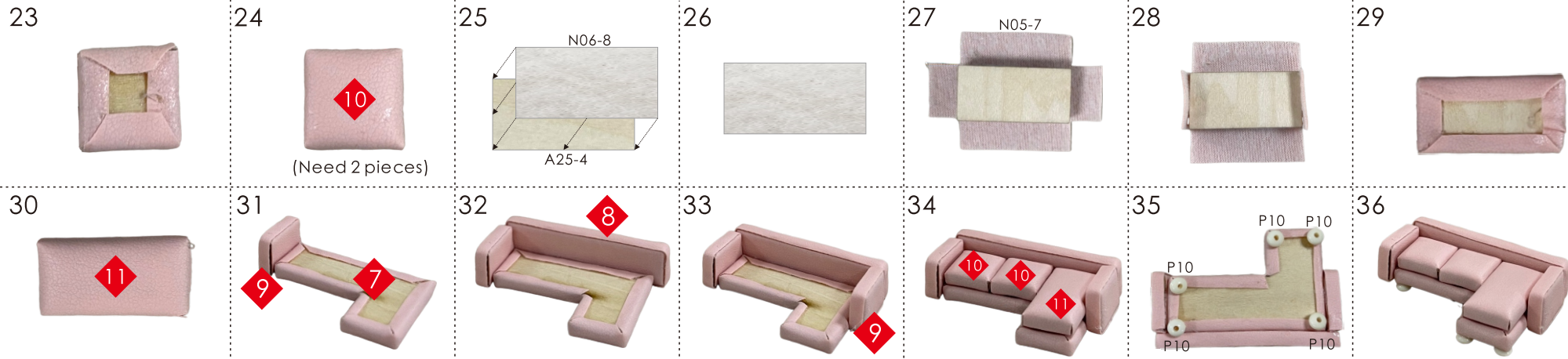

Cut out N03, N04, N06 and N10 according to the template before making

Double bed

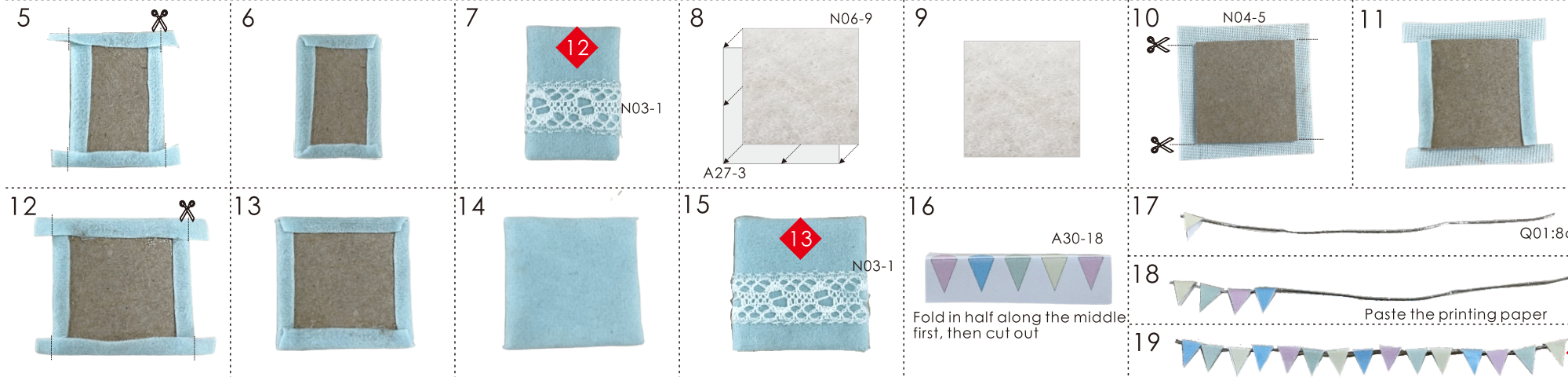
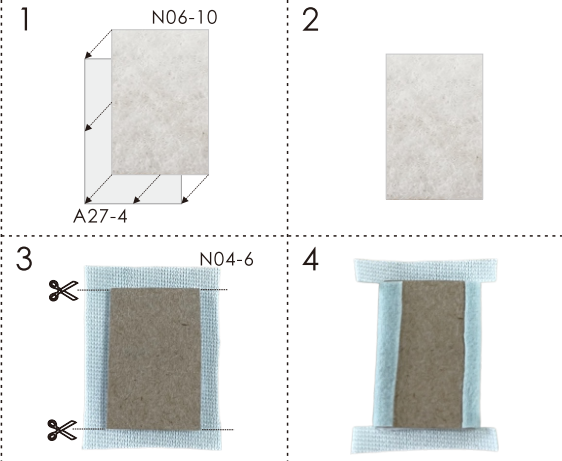
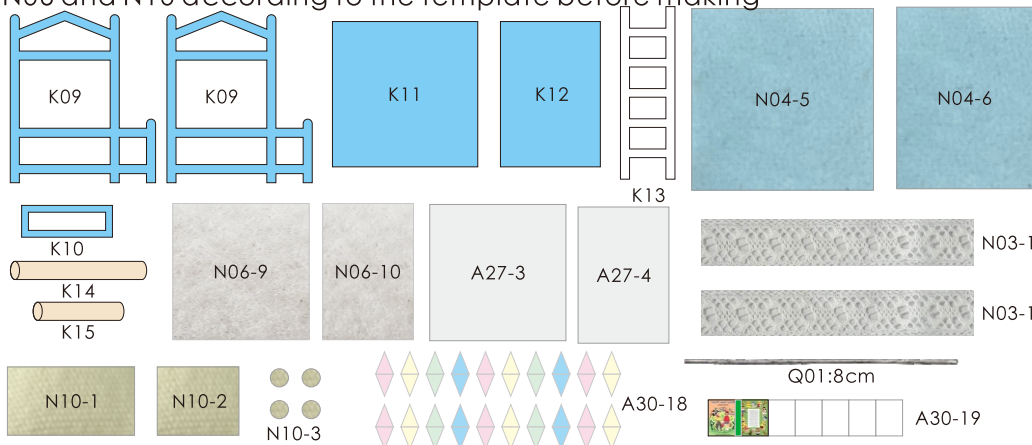

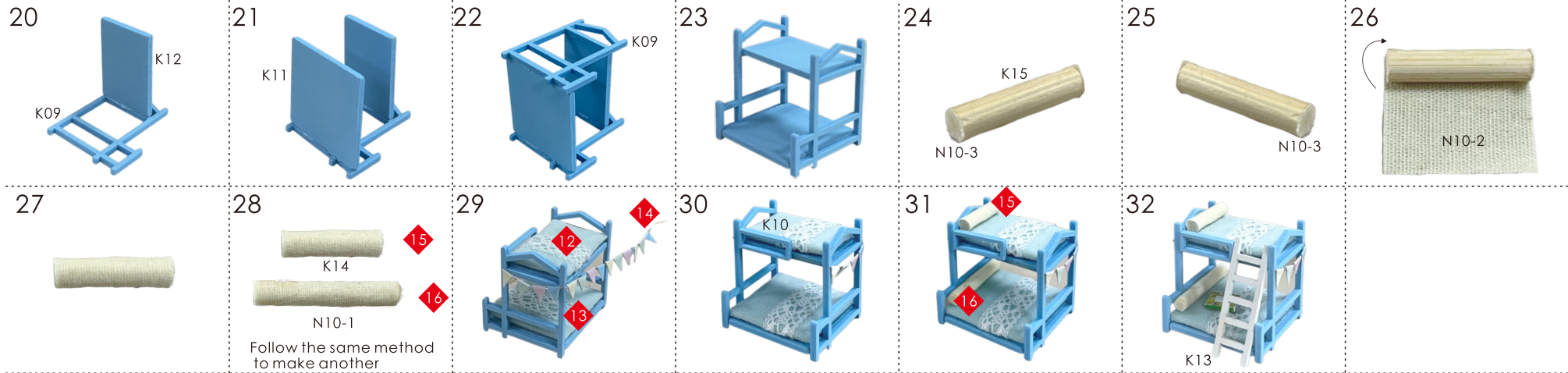

Cabinet

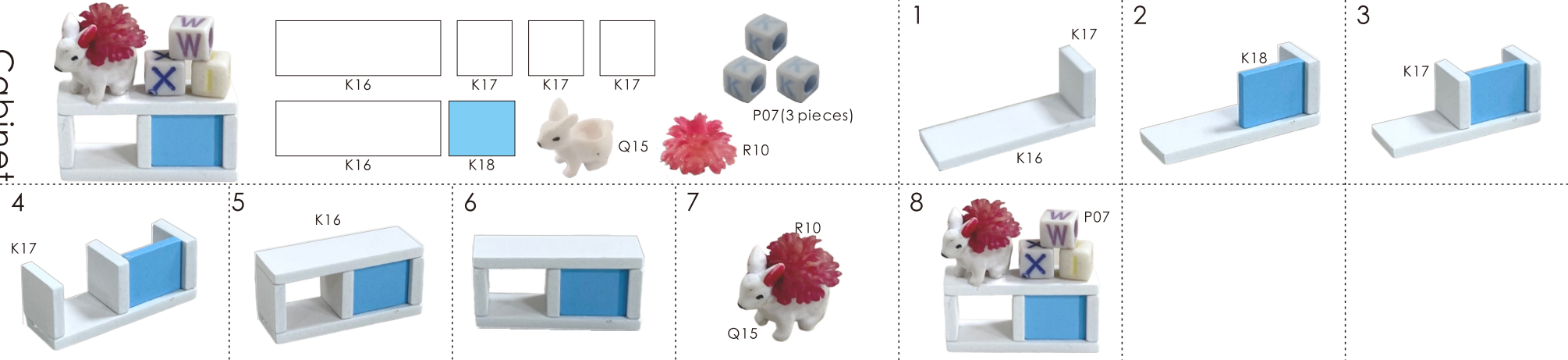

Floor umbrella

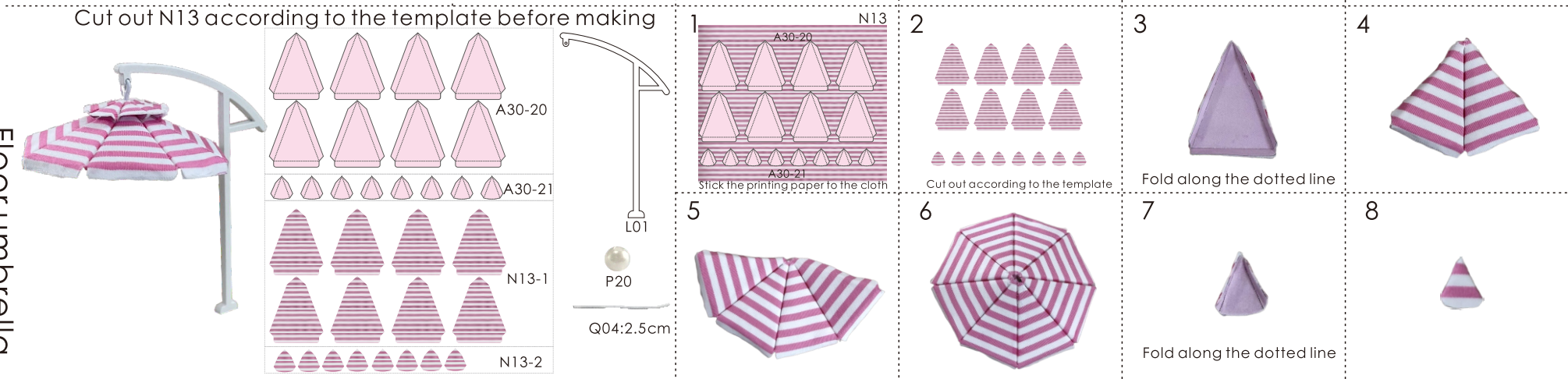

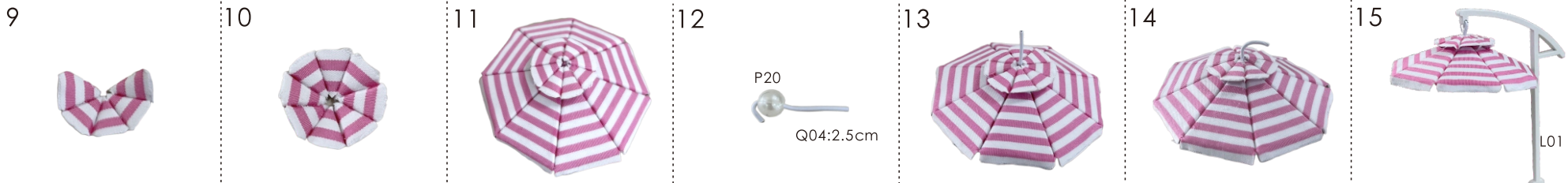

Cut out N01 and N09 according to the template before making

Rocking chair

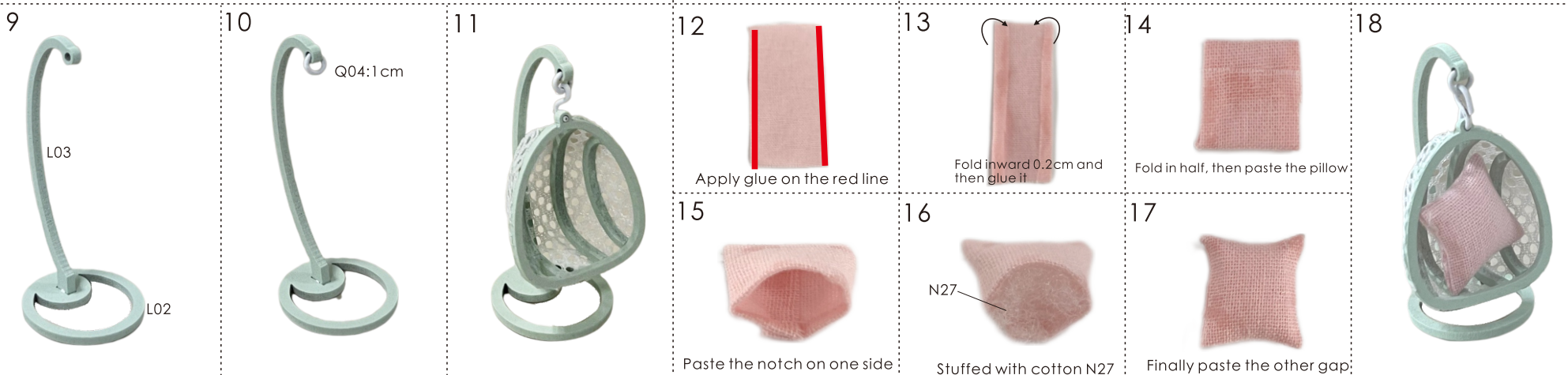
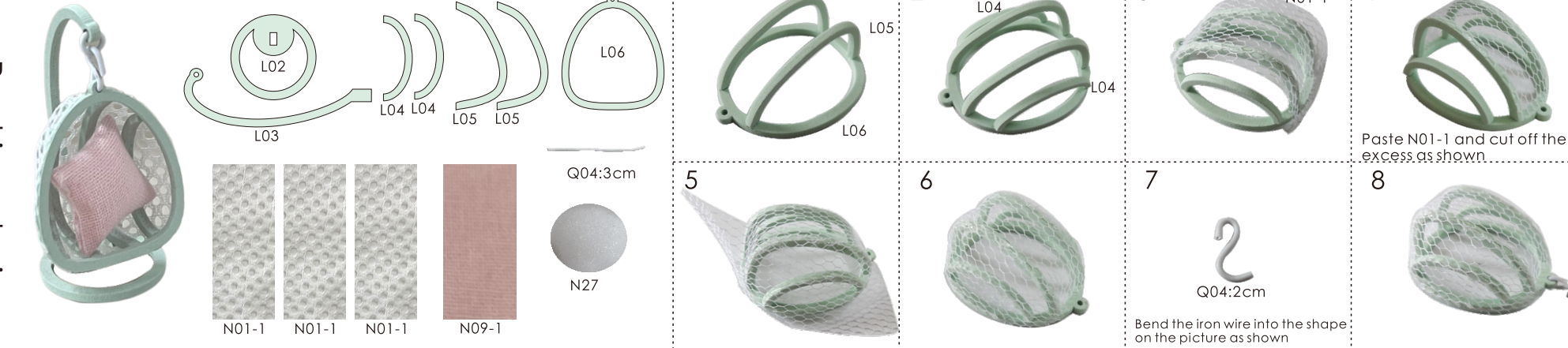

Cut out A27, N05 and N06 according to the template before making

Bed end stool

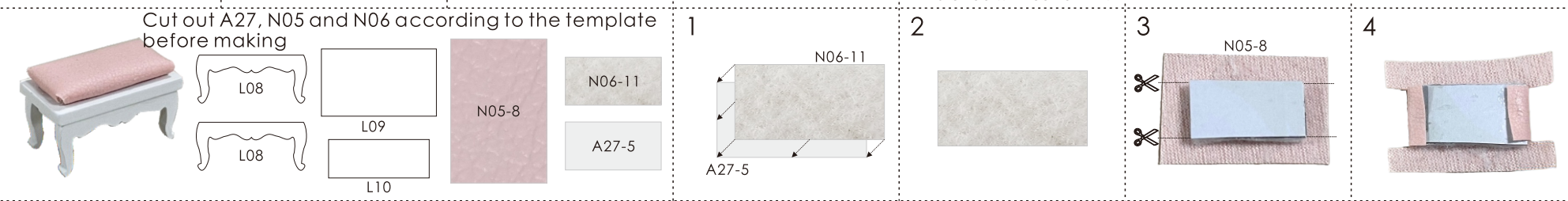

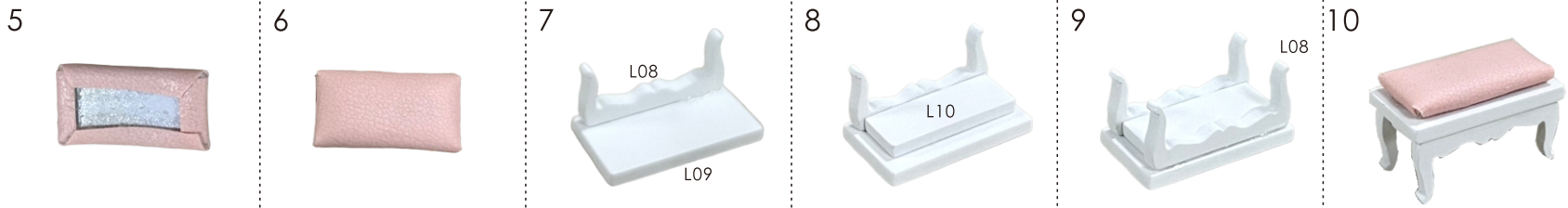

Cut out N02, N03, N05, N06, N08, N09 and N15 according to the template before making

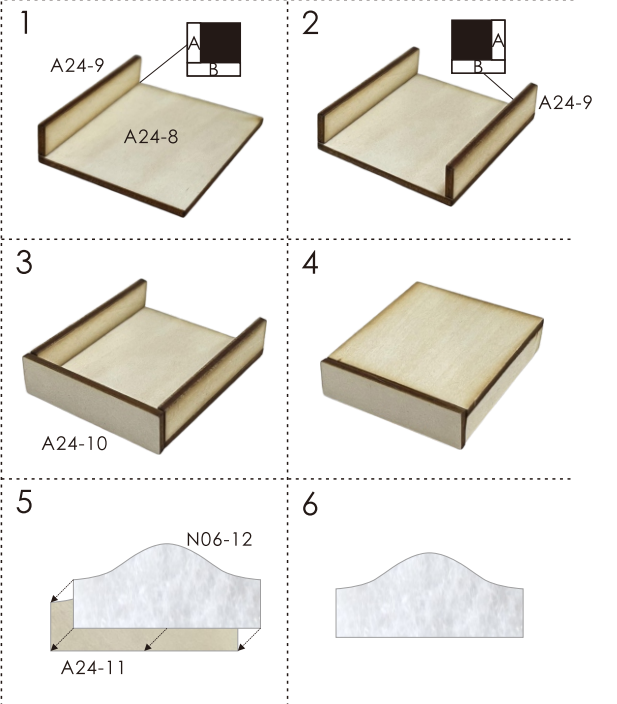
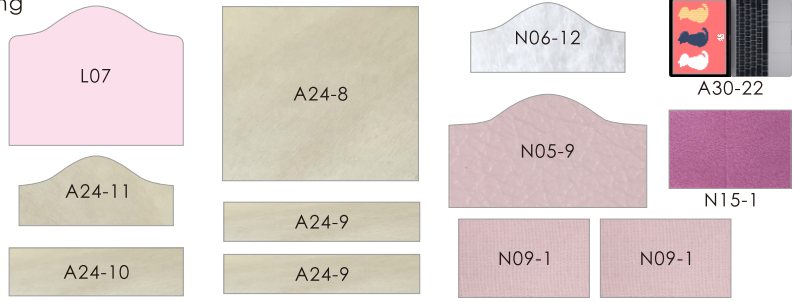

Bed

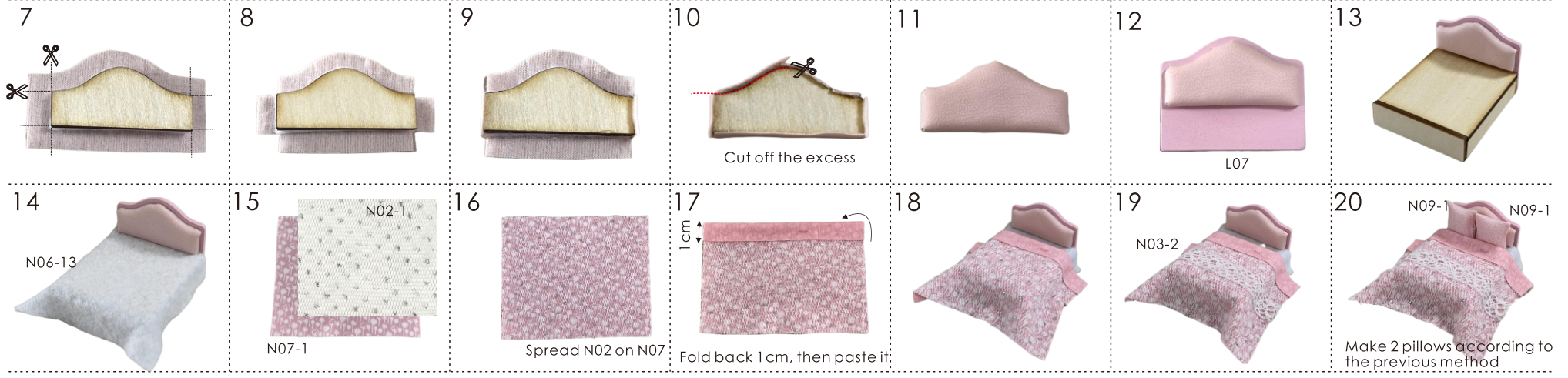





Piano

Cut out A27, N05 and N06 according to the template before making

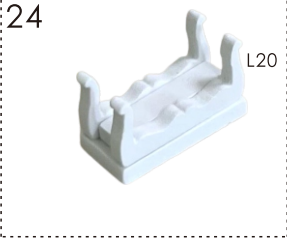
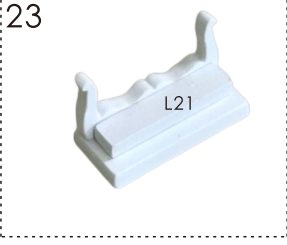
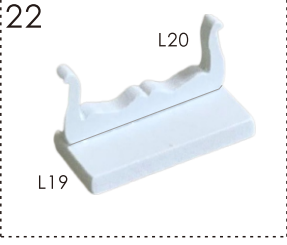
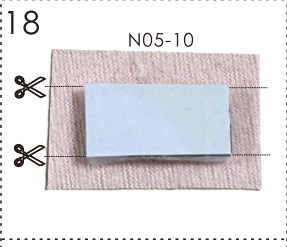
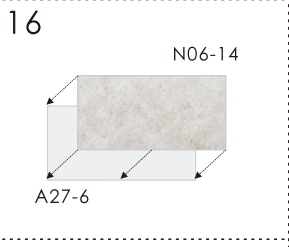
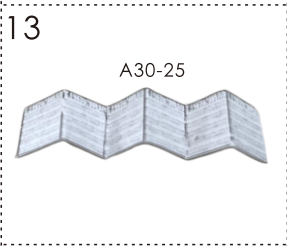
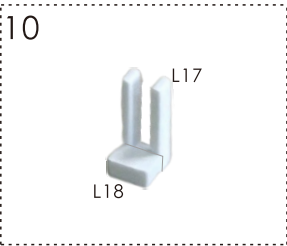
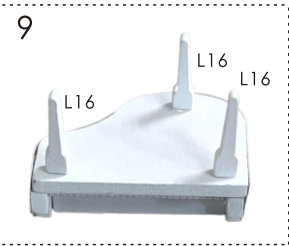
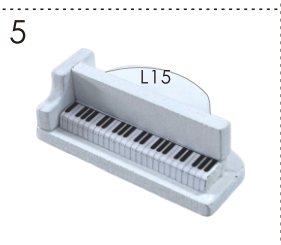
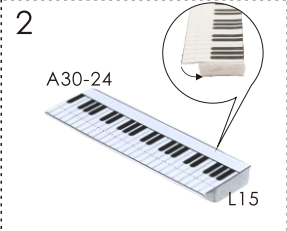
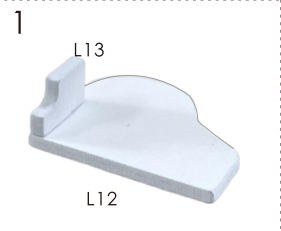
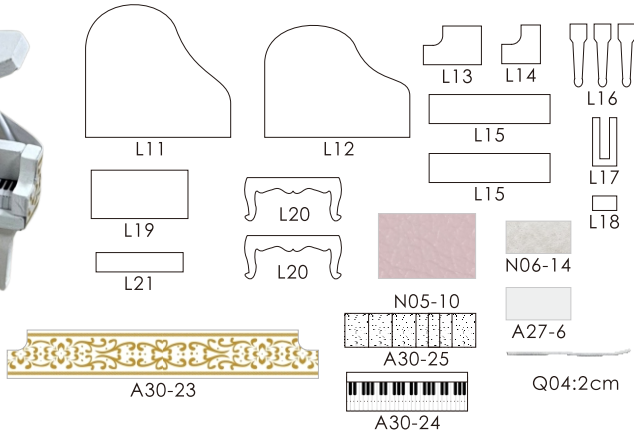

Tub

Cut out A26 according to the template before making

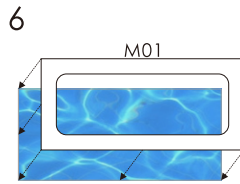
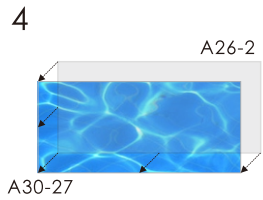
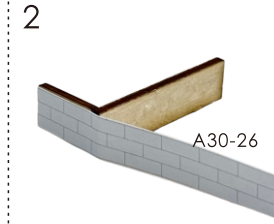
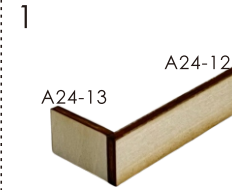
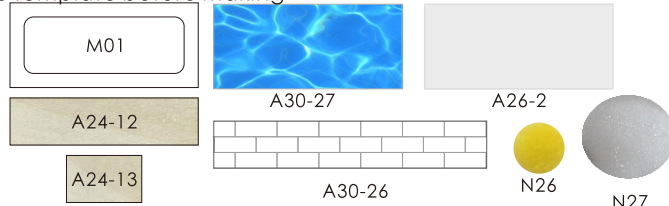

Bathroom cabinet

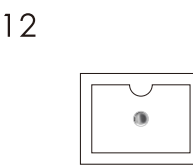
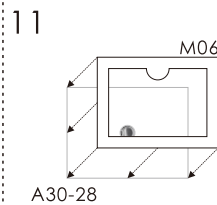
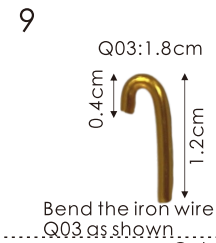
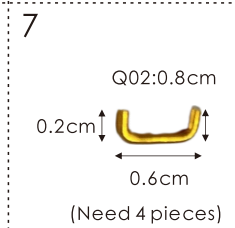
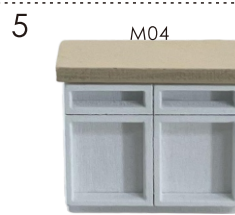
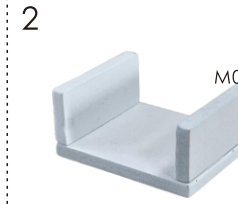
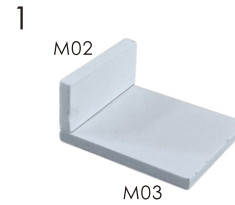
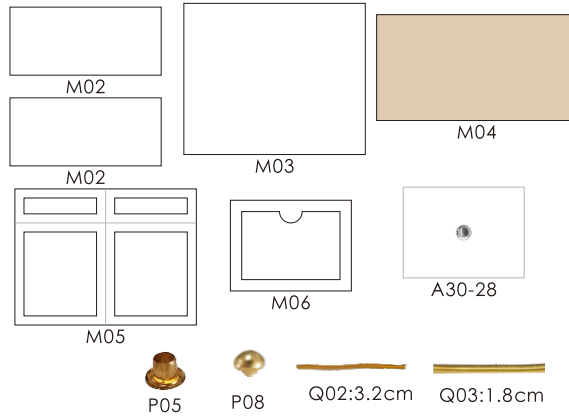

Plant 2



Cut out N18 according to the template before making

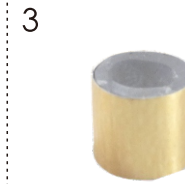
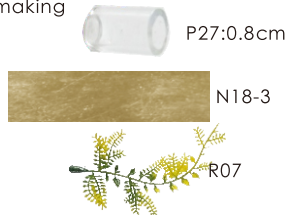

Drum kit

Cut out N18 according to the template before making

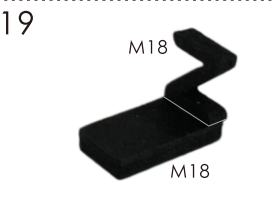
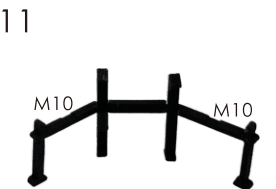
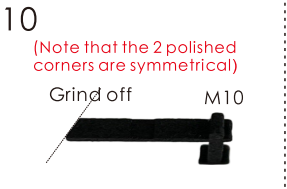
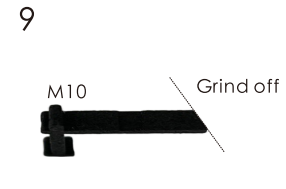
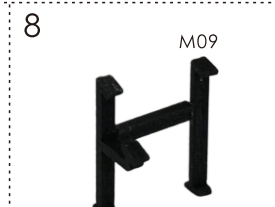
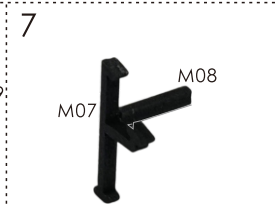
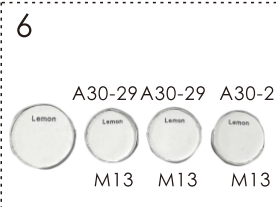
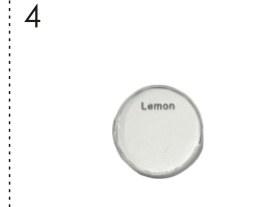
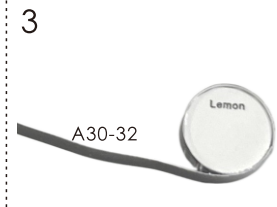
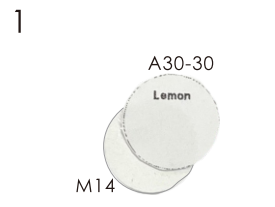
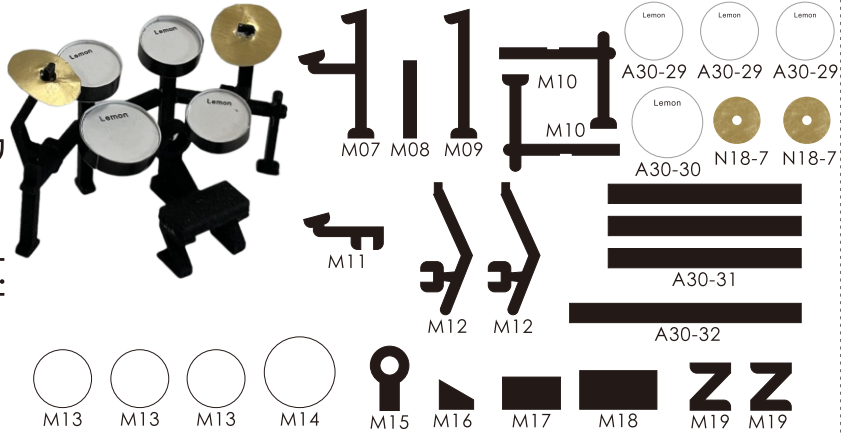



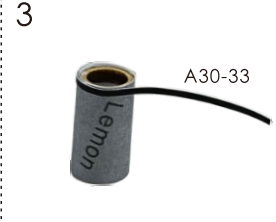
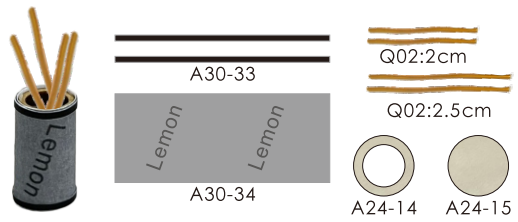

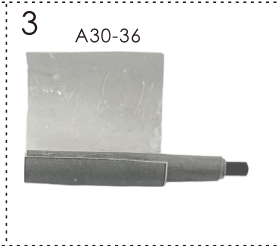
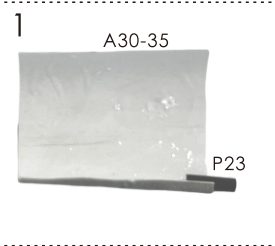
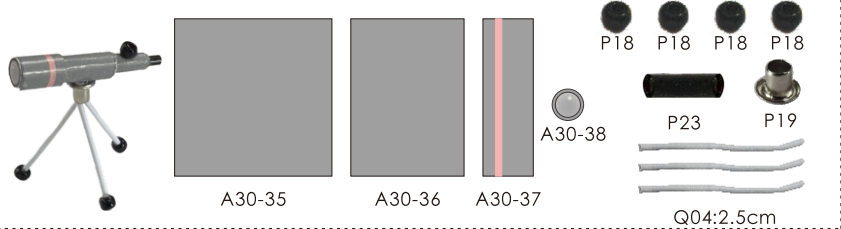

Drumsticks



Telescope

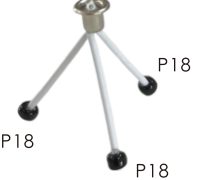

<p>5</p>  <p>A30-37</p>	<p>6</p>  <p>A30-38</p>	<p>7</p>  <p>0.3cm 2.2cm Q04:2.5cm</p> <p>(Need make 3 pieces) Bend the iron wire as shown in the picture.</p>	<p>8</p>  <p>P19</p>	<p>9</p>  <p>P18</p>	<p>10</p> 	<p>11</p>  <p>P18</p>
--	--	---	---	---	---	--

Fan Chandelier

Before making, cut out N18 according to the template

	 <p>A30-39</p>	 <p>N18-8</p>  <p>P15 P15</p>	<p>1</p>  <p>A30-39</p>	<p>2</p>  <p>Fold and glue A30-39 in half along the middle</p>	<p>3</p>  <p>Cut it out as shown in the picture</p>	<p>4</p>  <p>P15 P15</p> <p>Expand P15</p>
---	---	---	--	---	--	---



















<p>5 (front side)</p> 	<p>6 (back side)</p> 	<p>7</p>  <p>The chandelier made before</p>	<p>8</p> 	<p>9</p>  <p>N18-8</p>	<p>10</p>  <p>Wrap the wires with N18</p>	
---	--	--	--	---	--	--

As shown in the figure, stick the printing paper with the expanded P15





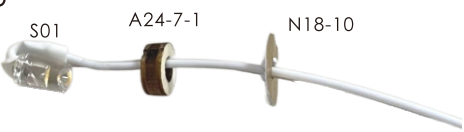













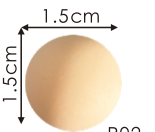

Use the chandelier made before, through the small hole of P15

Large chandelier

Before making, cut out N18 according to the template paper

	 <p>P02</p>  <p>P02</p>  <p>P02</p>  <p>A24-7-1</p>  <p>A24-7-1</p>  <p>A24-7-1</p>	 <p>N18-9</p>  <p>N18-10</p>  <p>N18-10</p>  <p>N18-10</p>  <p>S01</p>  <p>S01</p>  <p>S01</p>	<p>1</p>  <p>P02</p>  <p>N18-9</p>	<p>2</p> 	<p>3</p>  <p>S01 A24-7-1 N18-10</p> <p>(Note, test whether the bulb glows normally before making the lamp)</p>	<p>4</p>  <p>(Need make 3 pieces)</p>
--	--	---	---	--	---	---

Balloon

  <p>R01</p>  <p>R02</p>  <p>R03</p>  <p>R04</p>  <p>R05</p>  <p>Q01:6cm(6 pieces)</p>  <p>Q01:7cm(4 pieces)</p>  <p>P26</p>  <p>P26</p>	<p>1</p>  <p>1.5cm 1.5cm R02</p> <p>Knead R02 into a ball with a diameter of 1.5 cm as shown in the picture.</p>	<p>2</p>  <p>R02</p> <p>Take an appropriate amount and knead a long strip as the picture shown</p>	<p>3</p>  <p>Surround as shown, trim off the excess</p>	<p>4</p> 	<p>5</p>  <p>Q01:6cm</p> <p>Insert wire Q01 into R02</p>	<p>6</p>  <p>R01</p>  <p>R02</p>  <p>R03</p>  <p>R04</p>  <p>R05</p> <p>According the same steps to make other balloon</p>	<p>7 (Need make 2pieces)</p>  <p>P26</p> <p>Insert the balloon into P26 and fix it</p>
--	---	---	--	--	---	---	---

Slide

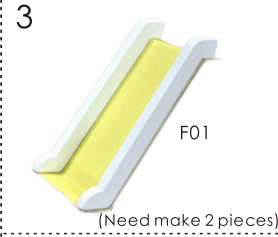
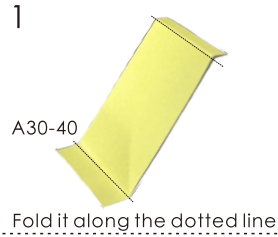
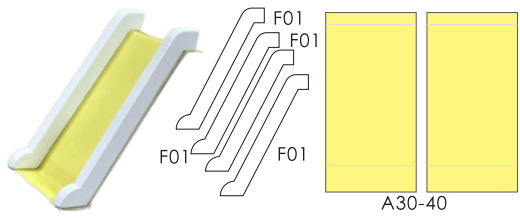

(Need make 2 pieces)

Step 1

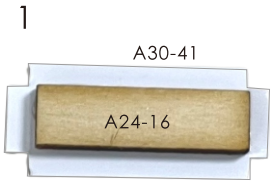
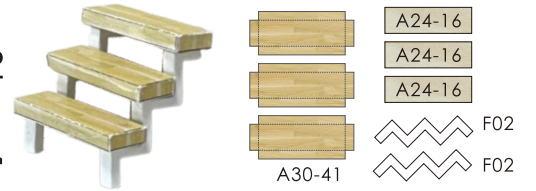

Step 2

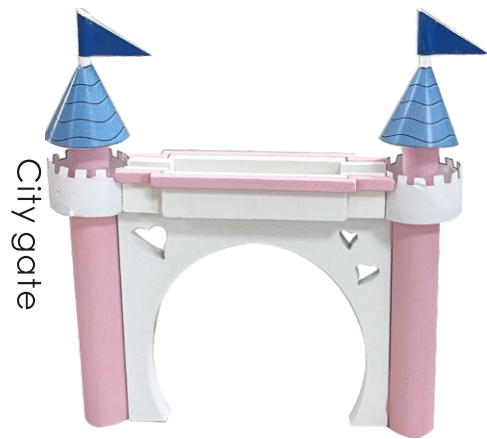
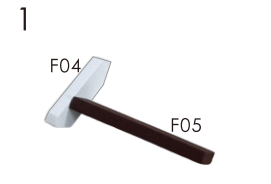
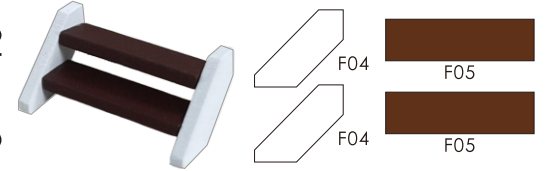

City gate

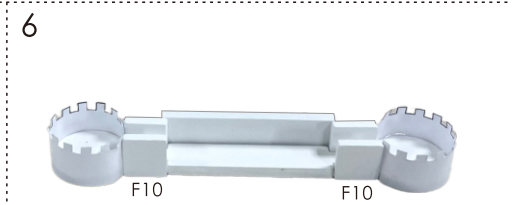
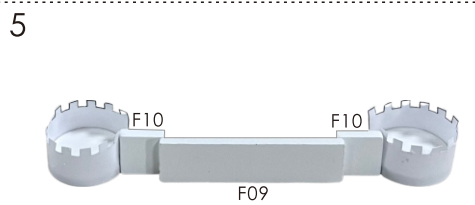
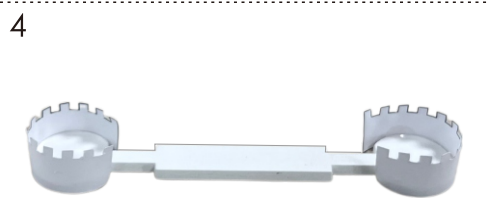
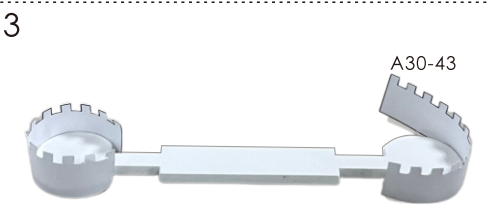
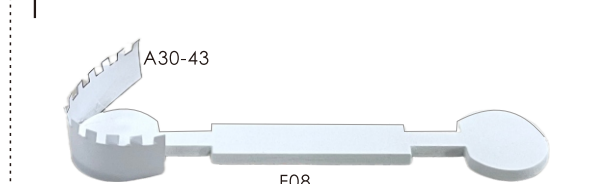
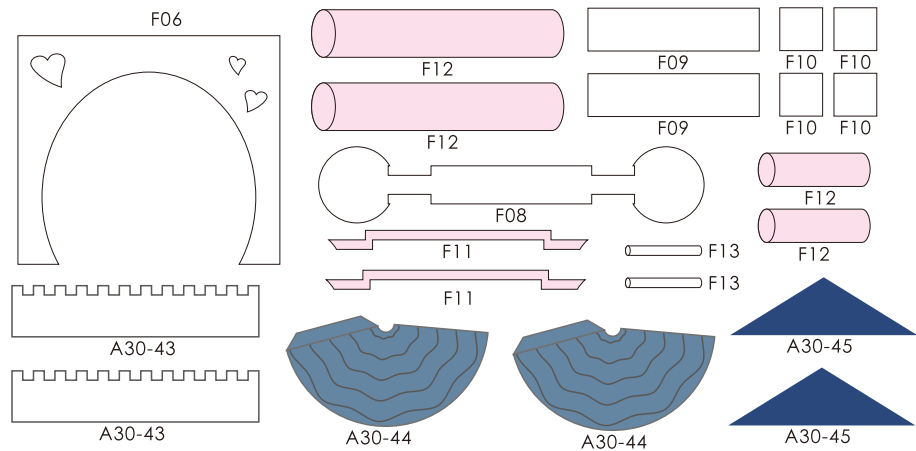

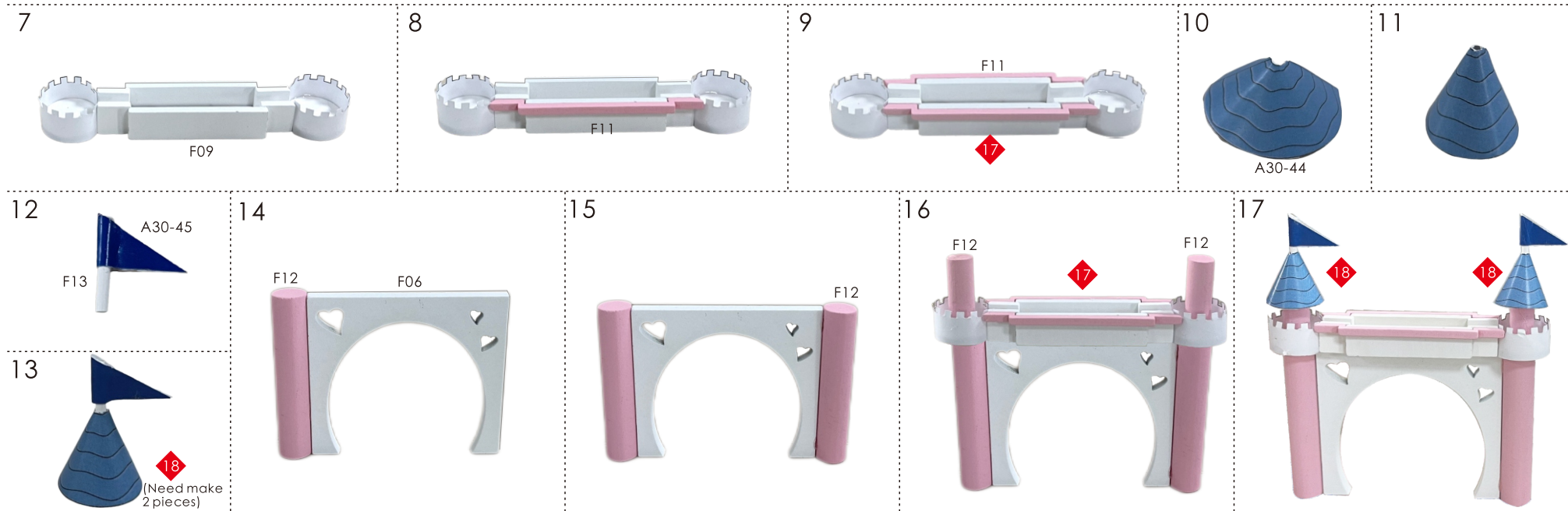

Bathroom divider

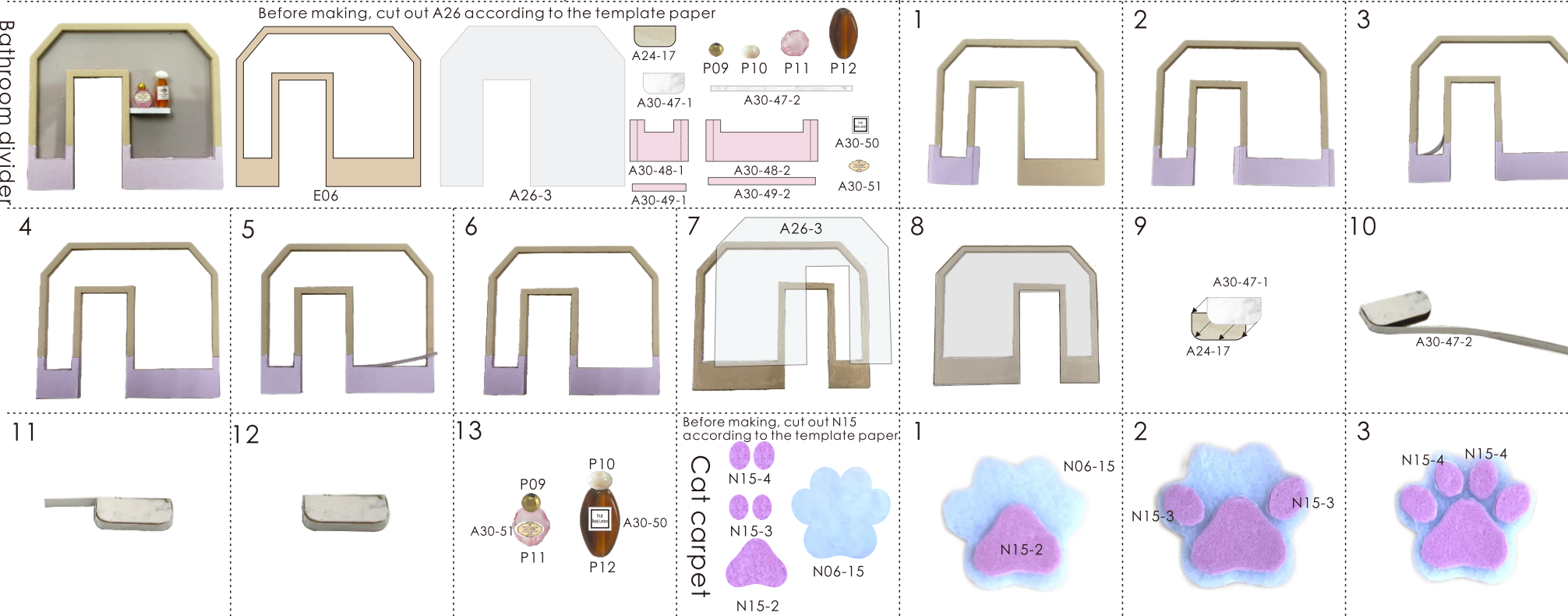

Kennel



Before making, cut out N04 and N06 according to the template paper



Lucky  
A30-52



Q14



A24-17-2

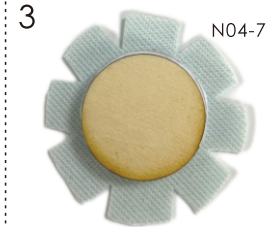

N04-7

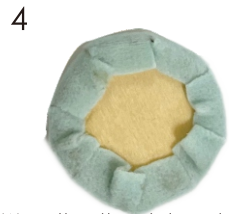

Wrap it as the picture shown



Fold it in half as shown in the picture



N04-8



A30-52



Slippers

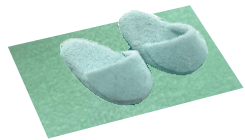

Before making, cut out A27, N04 and N28 according to the template

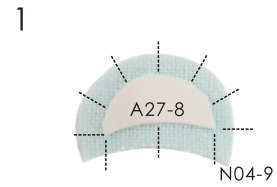
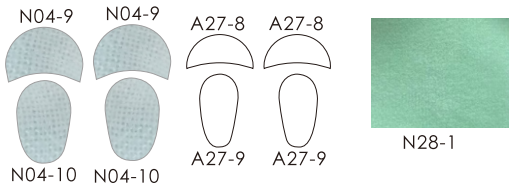

A27-8

N04-9



Wrap it as the picture shown

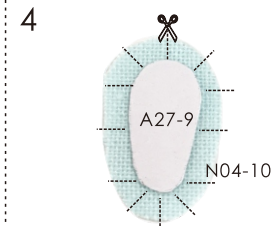

A27-9

N04-10



Wrap it as the picture shown



Before making, cut out N08 according to the template paper

Curtain

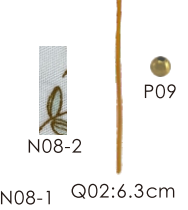

Fold N08-1 according to the template paper



N08-1

N08-2



Poke a small hole as shown in the picture

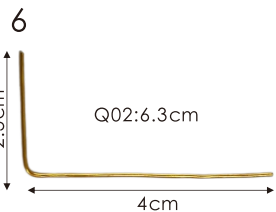

Q02:6.3cm

4cm

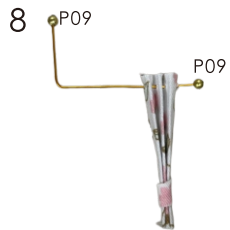

P09

P09

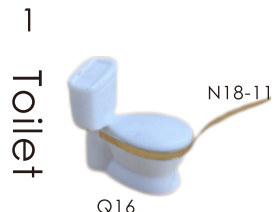

Toilet

Q16

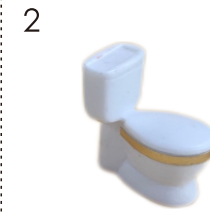

N18-11



Plant

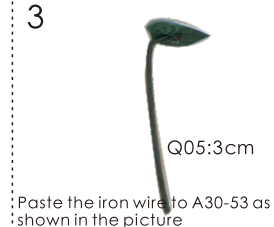
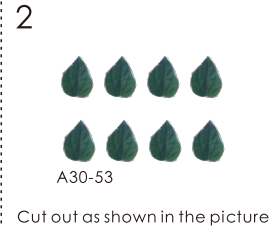
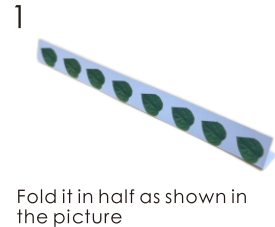
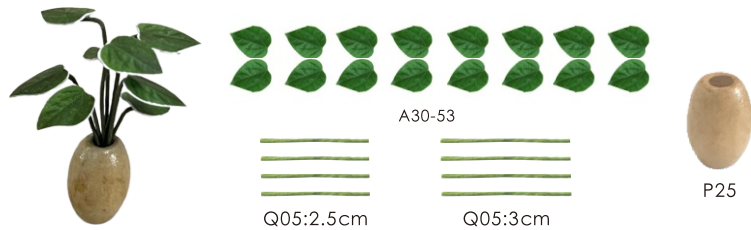

Sun flower

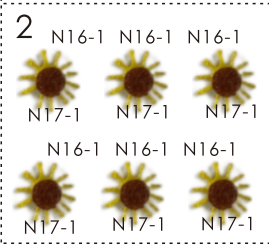
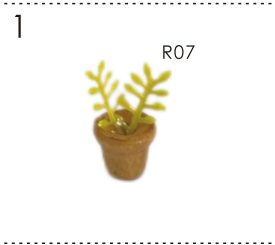
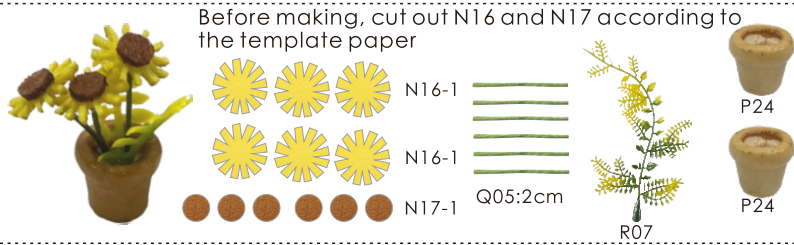

Stemless flowers

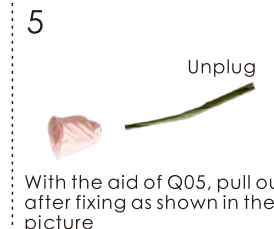
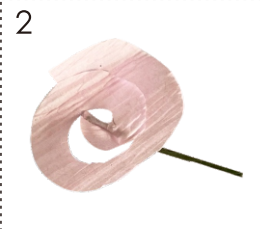
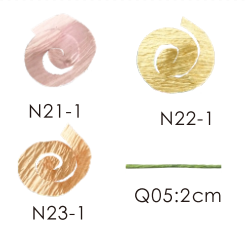

Third floor roof

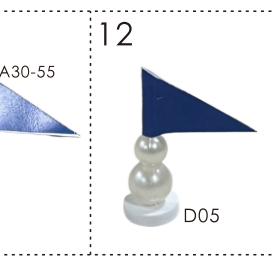
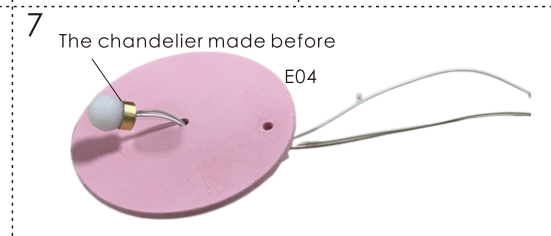
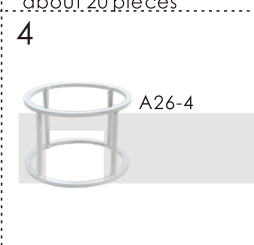
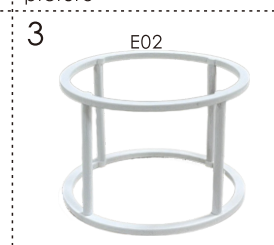
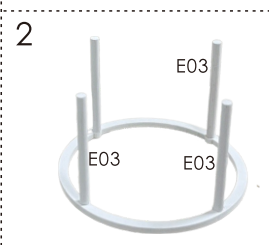
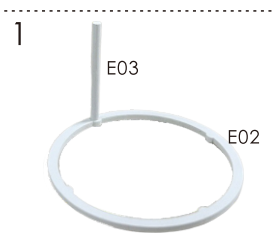
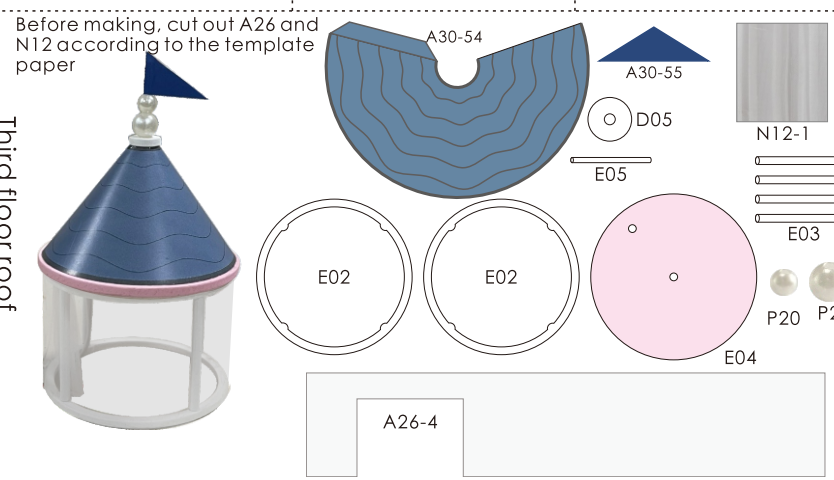



Elevator

Before making, cut out A26 according to the template

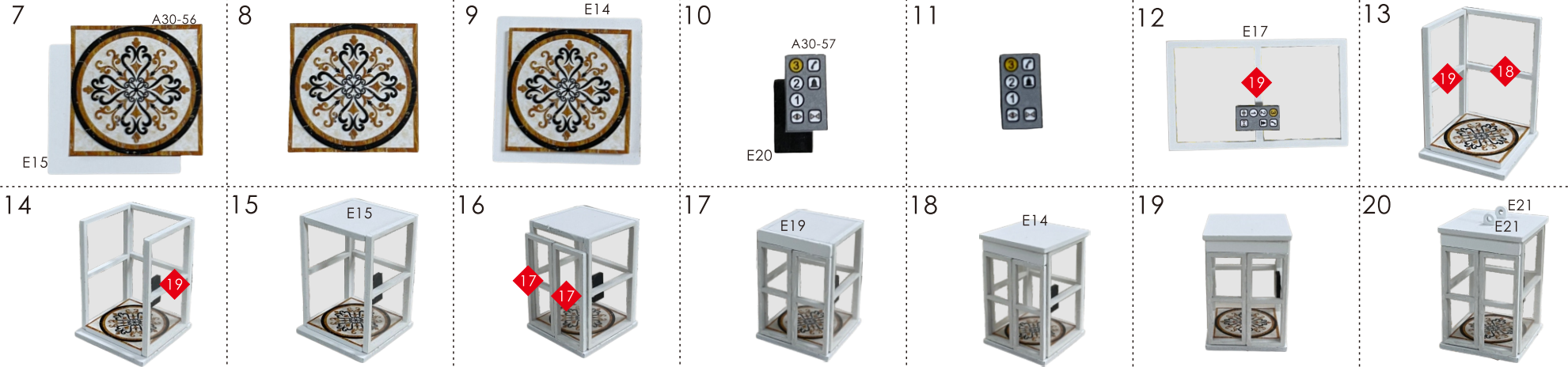
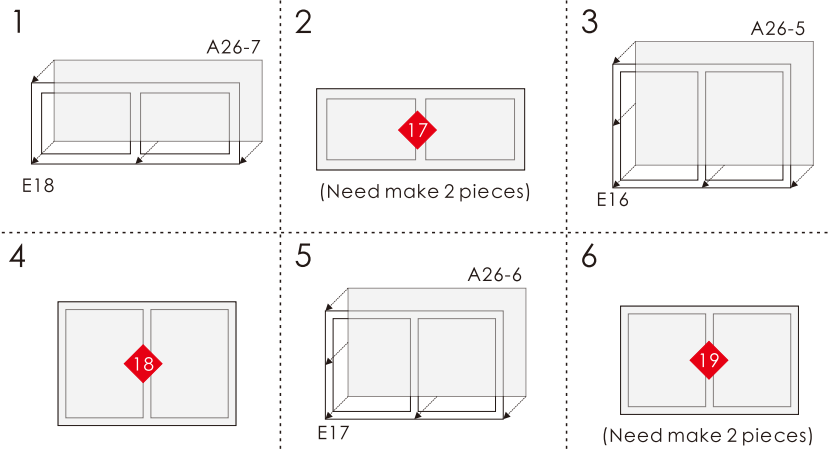
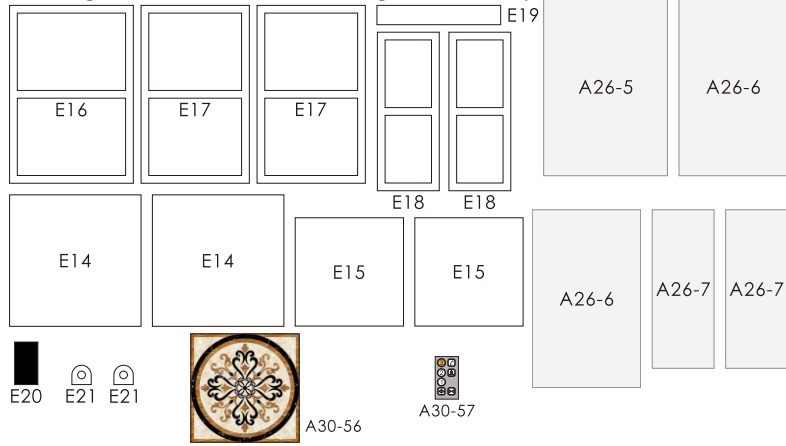

Elevator roof

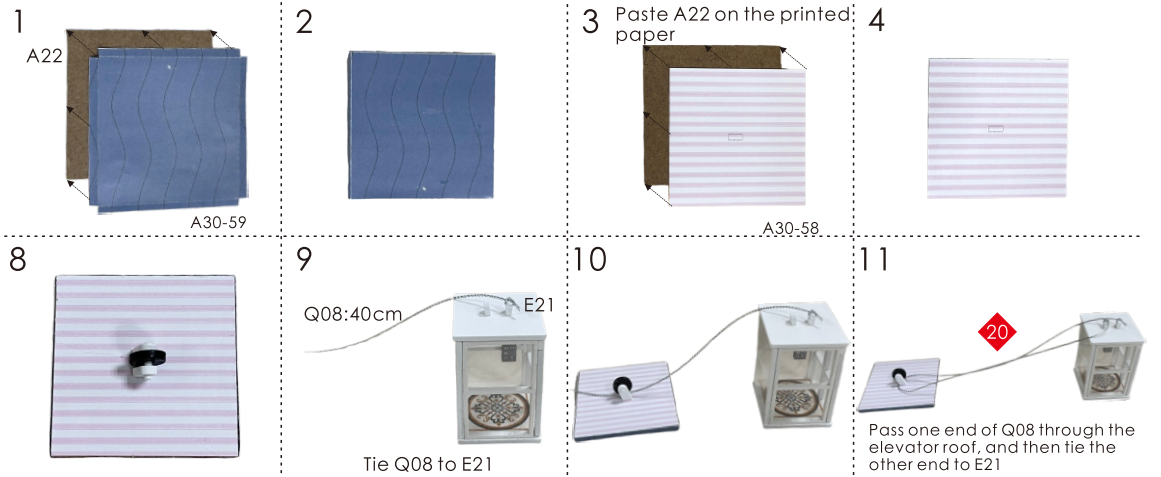
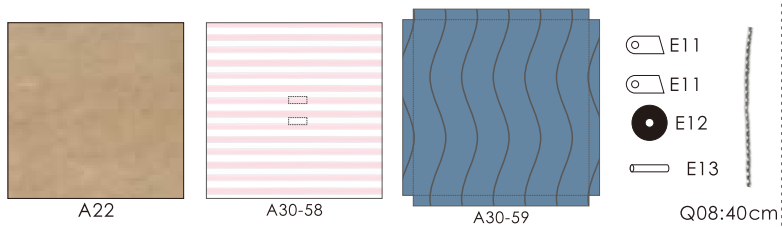

Elevator

Before making, cut out A26 according to the template paper

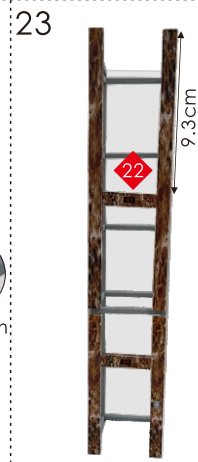
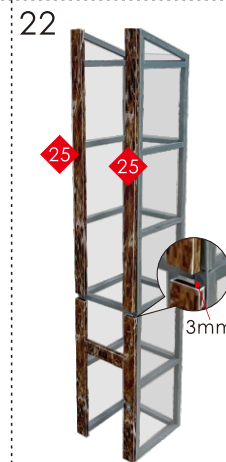
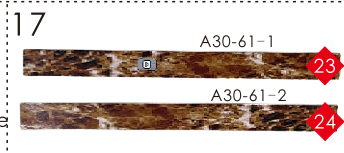
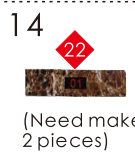
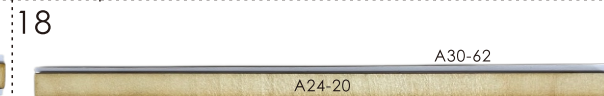
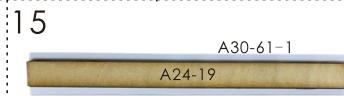
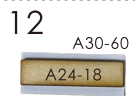
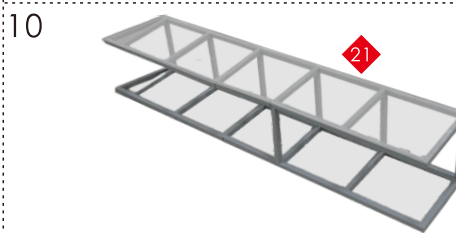
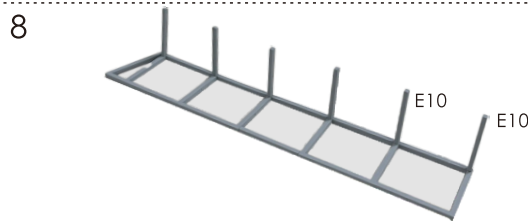
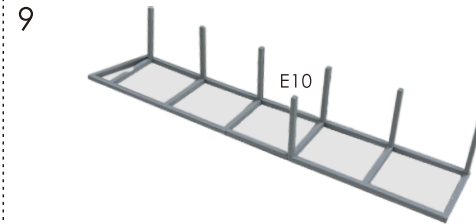
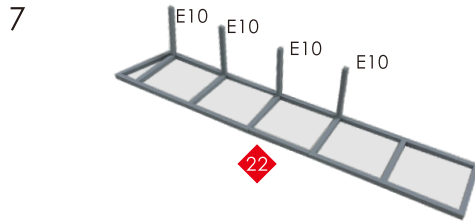
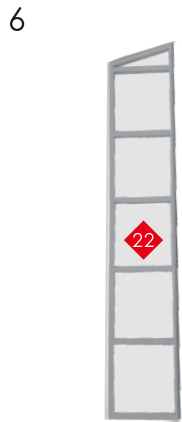
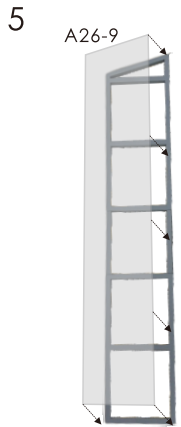
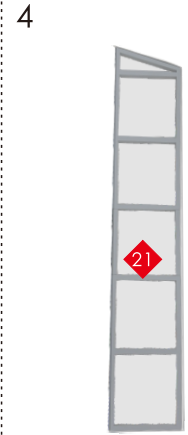
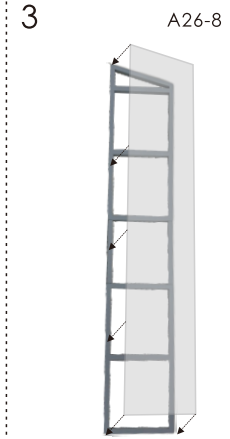
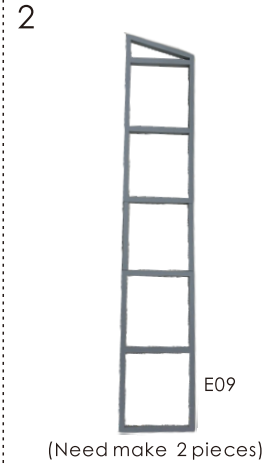
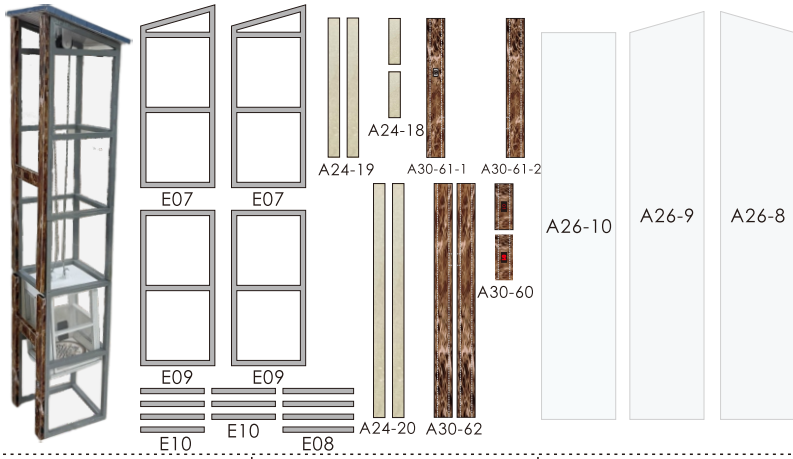

Third floor

Before making, cut out N11 according to the template paper

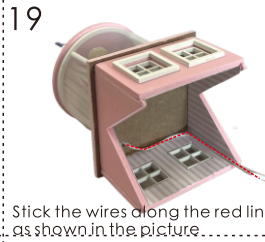
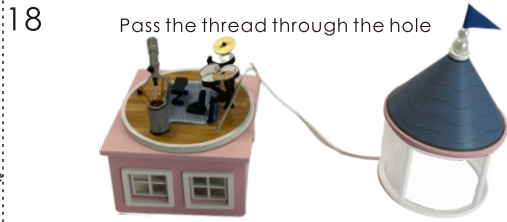
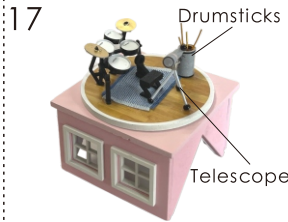
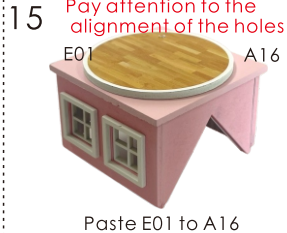
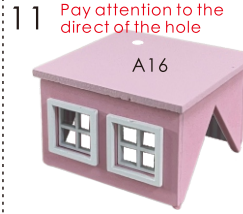
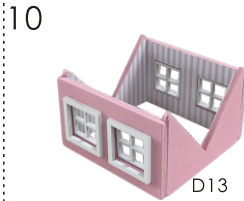
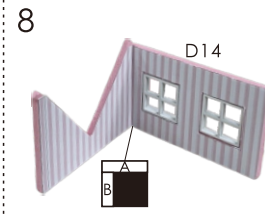
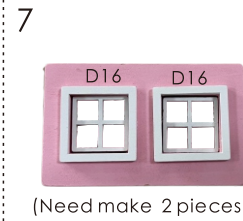
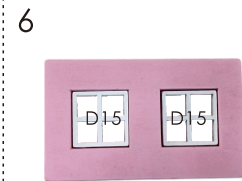
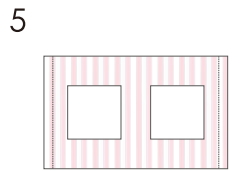
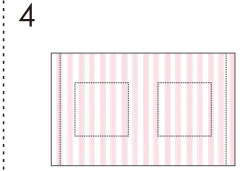
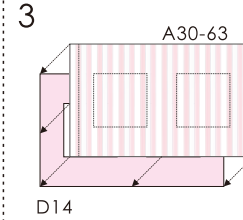
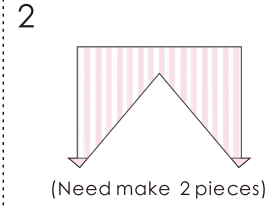
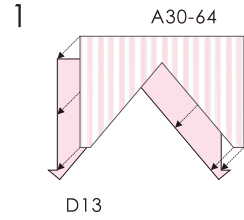
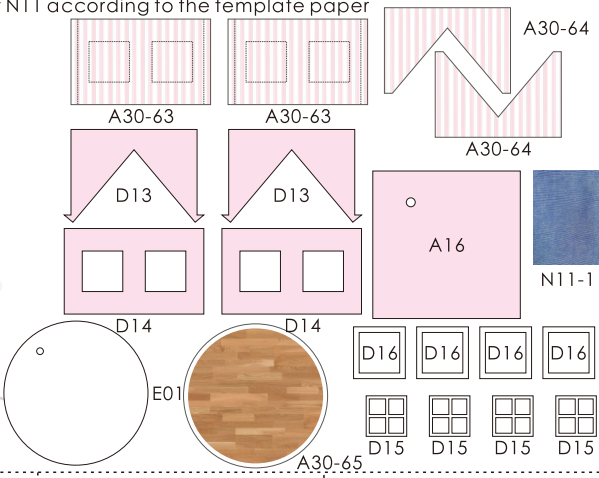

Piano room

Before making, cut out N01 according to the template paper

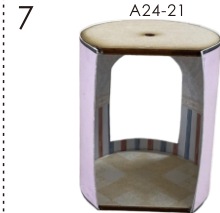
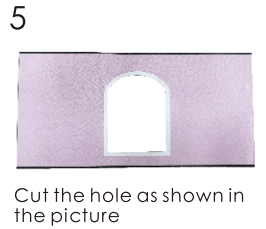
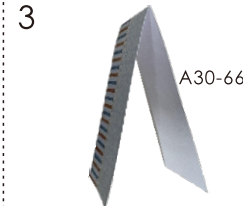
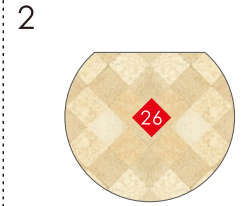
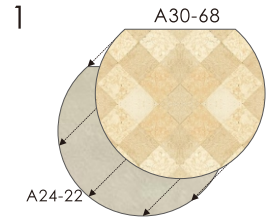
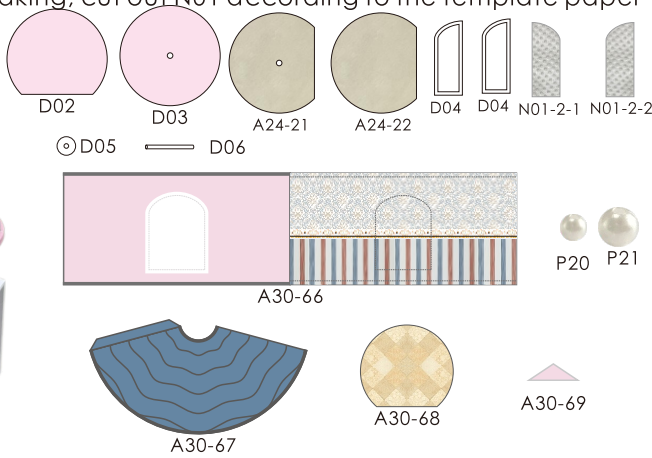

<p>8 The chandelier made before</p>	<p>9</p>	<p>10 A30-67</p>	<p>11</p>	<p>12 D04</p> <p>N01-2-1</p>	<p>13</p> <p>27</p>	<p>14 D04</p> <p>N01-2-2</p> <p>Use same steps to make other one</p>
<p>15 D06</p> <p>P20 A30-69 P21 D05</p> <p>Note: When D06 can't fit the beads, need poke the hole bigger first</p>	<p>17</p> <p>28</p>	<p>18</p> <p>Cut a notch on A30-67, then glue it.</p>	<p>Before making, cut out N01 according to the template paper</p> <p>Spire on the third floor</p> <p>D07 A24-23 D09 D10 D08 D08 N01-3-1 N01-3-2</p> <p>A30-70 A30-71 A30-72</p>			<p>1</p> <p>A30-71</p> <p>Fold and glue A30-71 in half as shown in the picture</p>
<p>16</p>	<p>28</p>	<p>28</p>	<p>3</p>	<p>4</p> <p>Cut the hole as show in the picture</p>	<p>5</p> <p>A24-23</p>	<p>2</p>
<p>3</p>	<p>4</p> <p>Cut the hole as show in the picture</p>	<p>5</p> <p>A24-23</p>	<p>6</p>	<p>7</p>	<p>8 A30-70</p>	<p>9</p>
<p>10</p> <p>D07</p>	<p>11 A30-72</p> <p>D10 P20</p> <p>Note: When D10 can't fit the beads, you can poke the hole bigger first</p>	<p>12 D09</p>	<p>16</p>	<p>17</p> <p>30</p>	<p>Kitchen floor</p> <p>A23 A30-73-1</p>	<p>1 A23</p> <p>A30-73-1</p>
<p>13 D08</p> <p>N01-3-1</p>	<p>14</p> <p>29</p>	<p>15 D08</p> <p>N01-3-2</p> <p>Make another one in the same way</p>	<p>17</p> <p>30</p>	<p>17</p> <p>29</p>	<p>2</p> <p>Fold one side up and glue it</p>	<p>3</p>

Daylighting windows on the third floor.	<p>Before making, cut out A26 according to the template paper</p>	<p>1</p>	<p>2</p>	<p>3</p>	<p>4</p> <p>(Need make 2 pieces)</p>
	Balcony 1		<p>1</p>	<p>2</p>	<p>3</p>
Balcony 2			<p>1</p> <p>Stick to the wood-colored side</p>	<p>2</p>	<p>3</p>
	Balcony 3		<p>1</p>	<p>2</p>	<p>3</p>
Children's room		<p>Before making, cut out N18 according to the template paper</p>	<p>1</p> <p>Glue A30-79 to N18-12</p>	<p>2</p> <p>(Front view)</p>	<p>3</p> <p>Stick on B09</p>
	<p>5</p>	<p>6</p> <p>The chandelier made before</p> <p>Glue the previously made chandelier to the roof</p>	<p>7</p> <p>A14</p>	<p>8</p>	

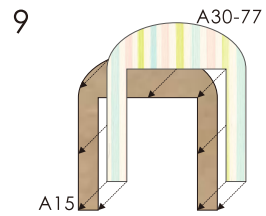

Stick to the wood-colored side

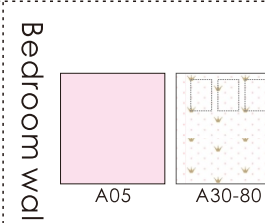
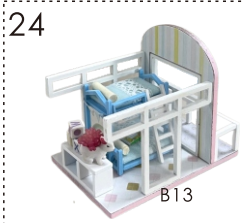
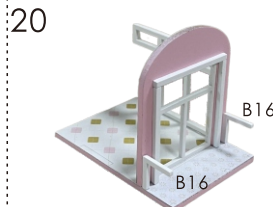
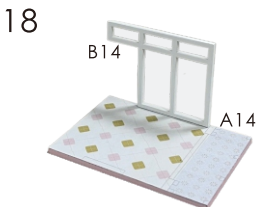
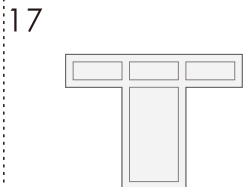
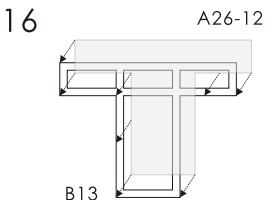
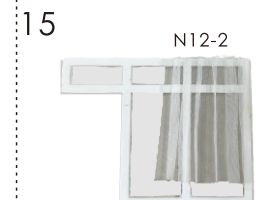
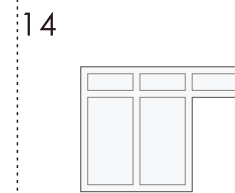
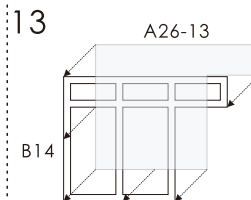
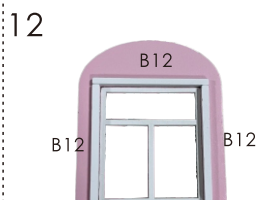
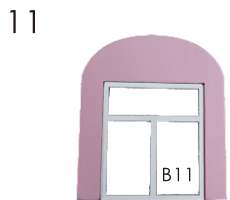
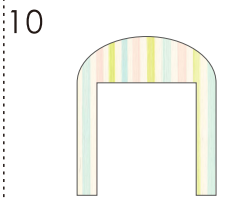

Bedroom wall

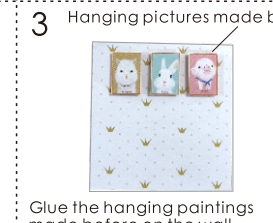
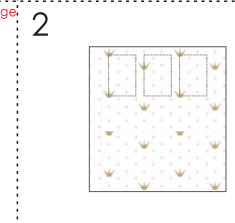
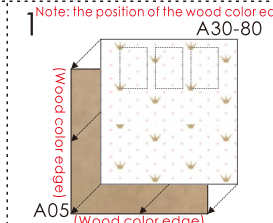

Before making, cut out N18 according to the template paper

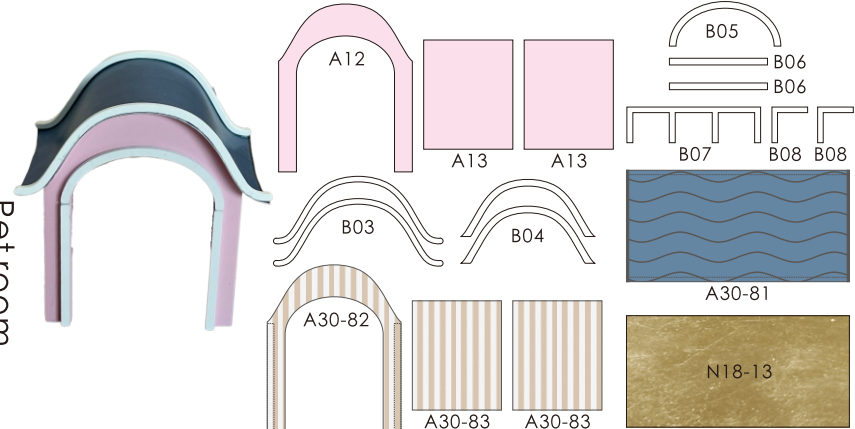

Bedroom

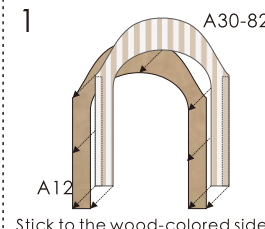

Stick to the wood-colored side

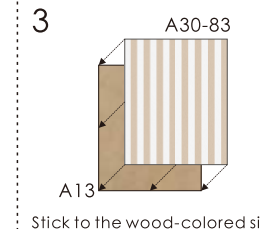
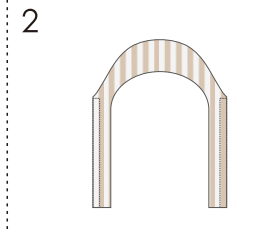

Stick to the wood-colored side

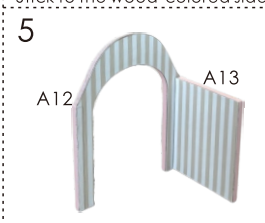
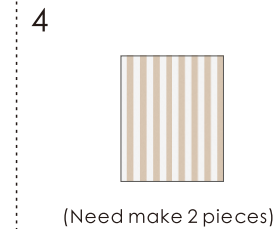

Stick to the wood-colored side

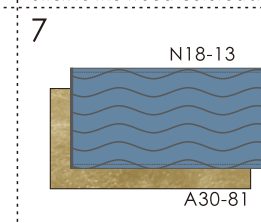
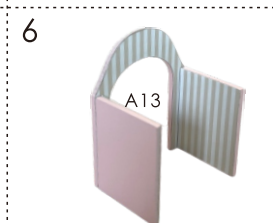

Glue A30-81 to N18-13

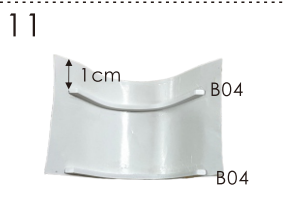
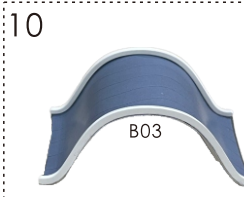
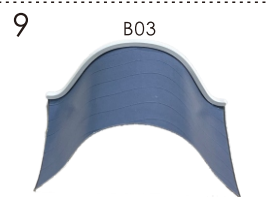
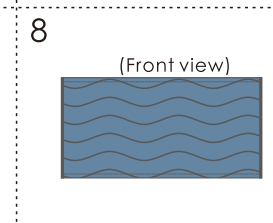

Glue the previously made chandelier to the roof

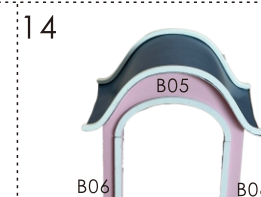

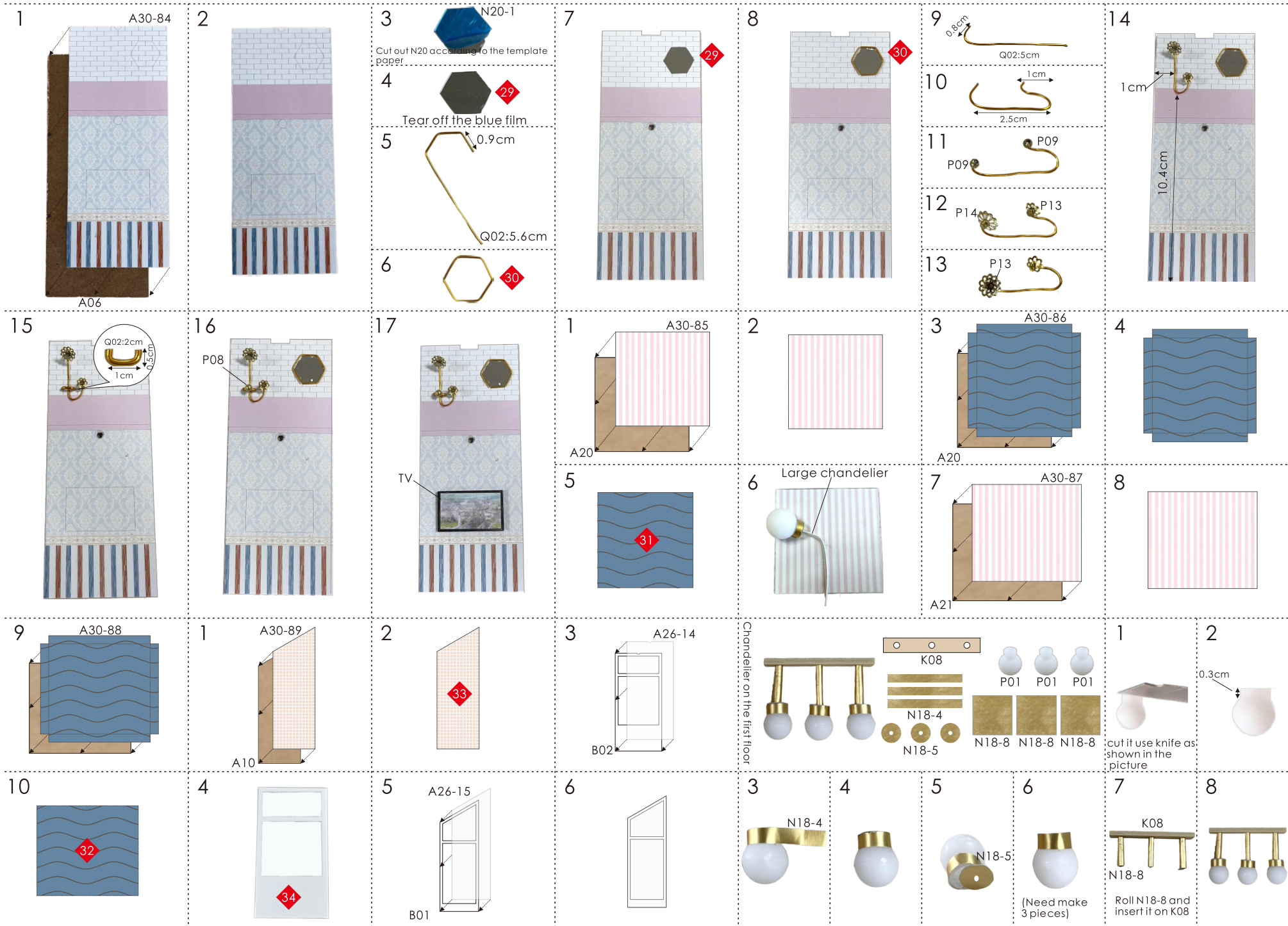

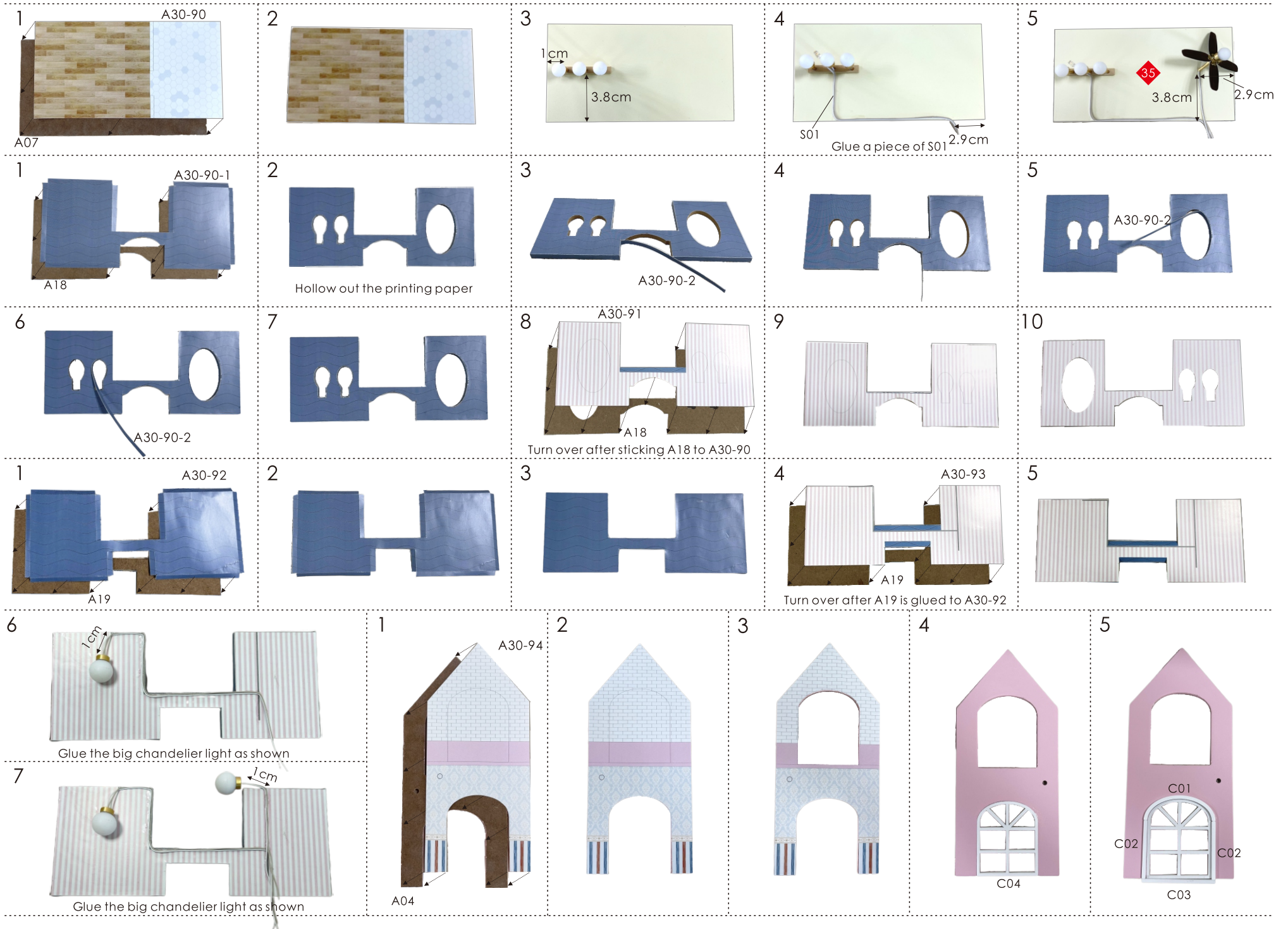



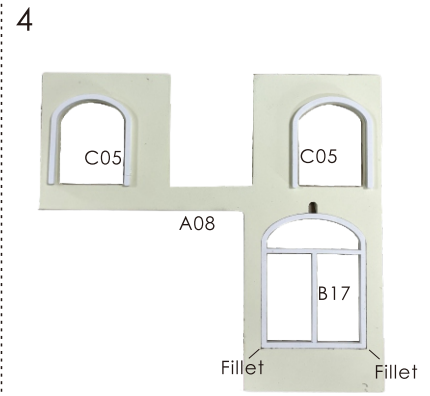
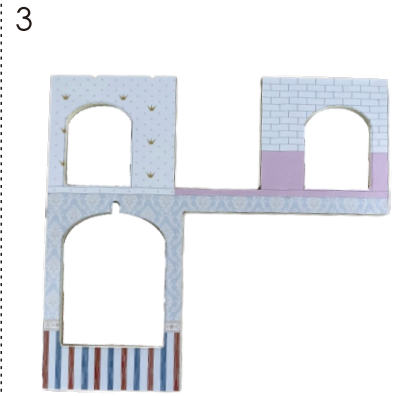
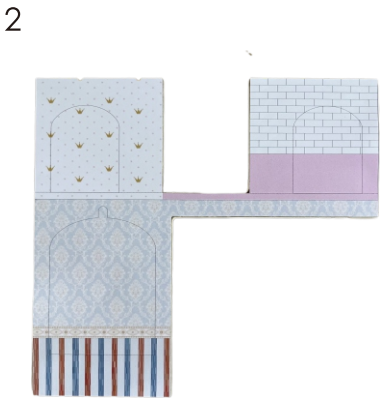
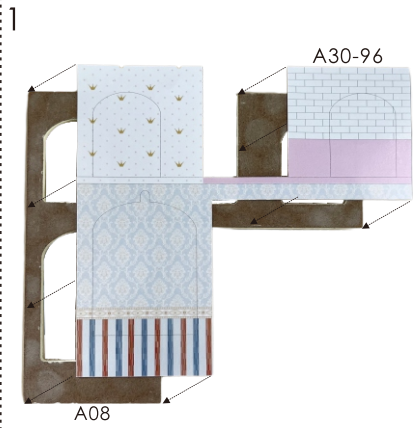
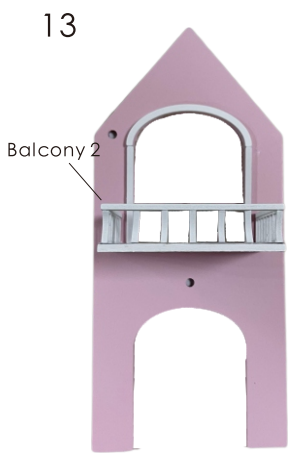
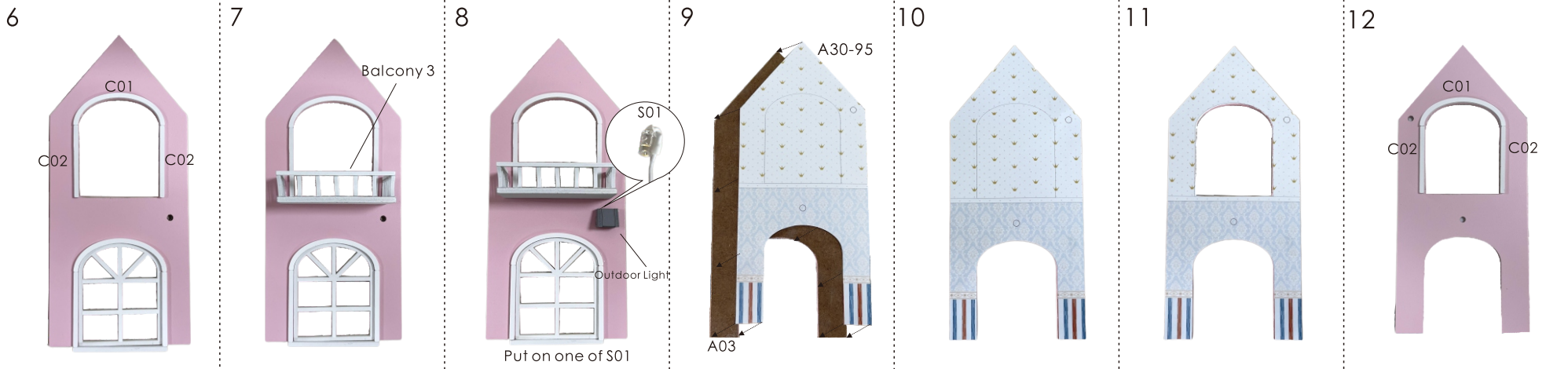

If B17 cannot be placed in A08, cut the fillet of A08 into a right angle with a knife and polish the edge of B17

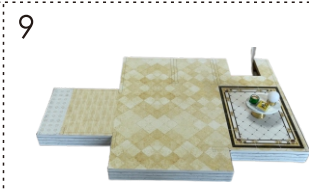
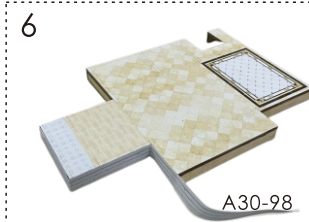
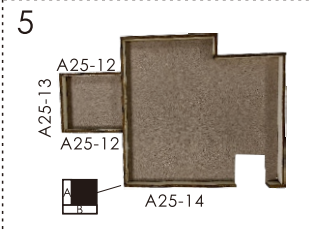
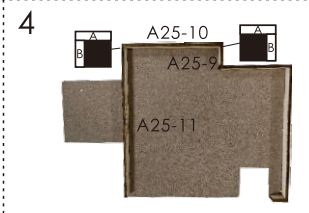
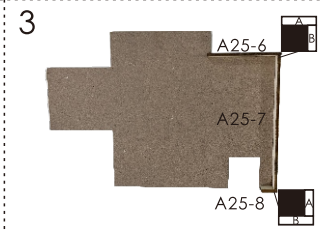
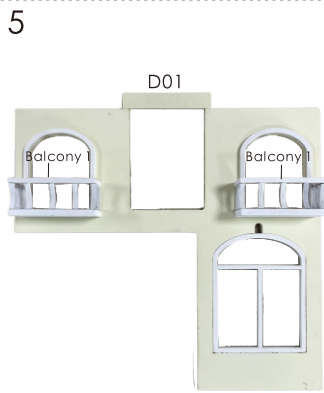

Swimming pool

6

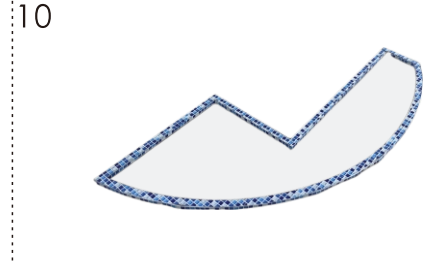
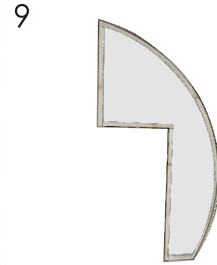
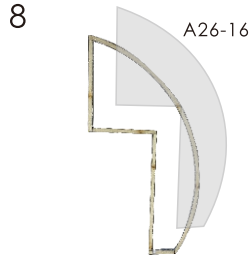
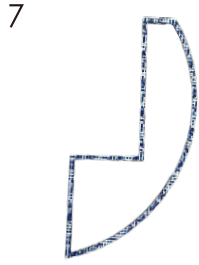
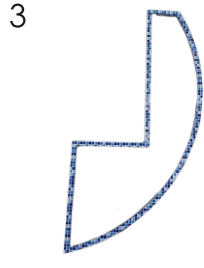
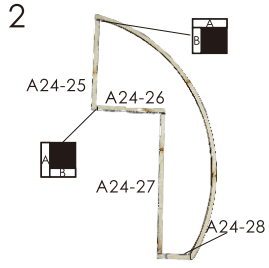
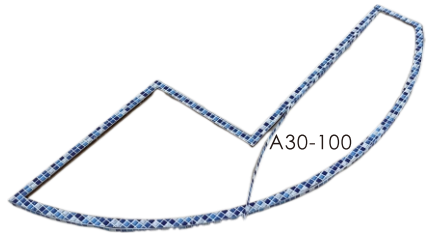

Bottom plate

5

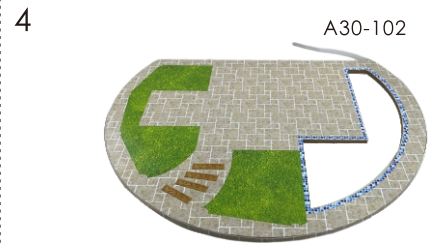
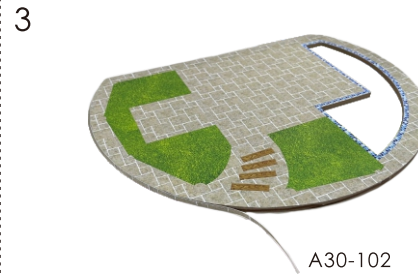
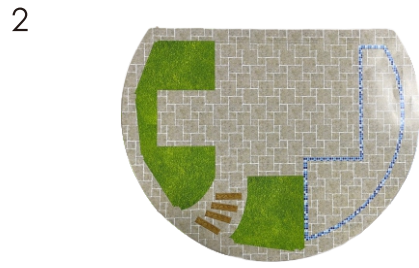

9



Glue the printing paper A30-104 to A01

Glue S02 as shown in the picture

Cover the wires with printed paper

Stick on the swimming pool printing paper

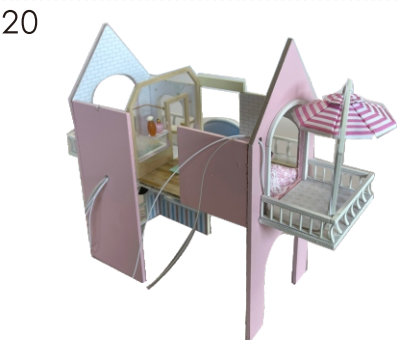
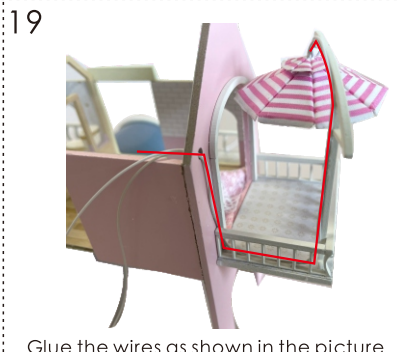
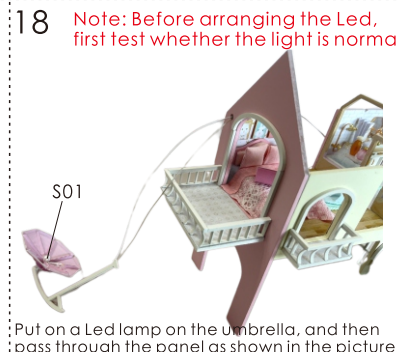
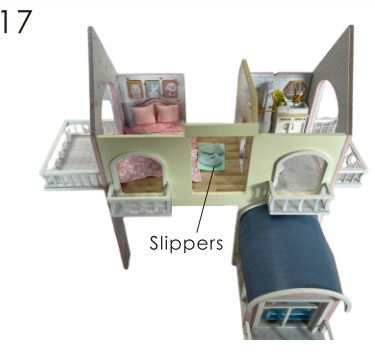
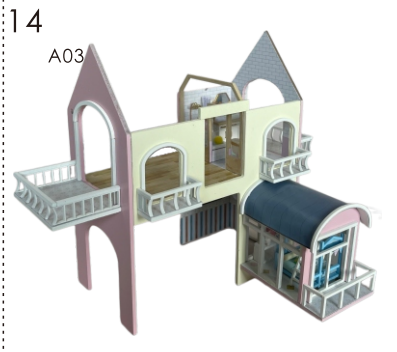
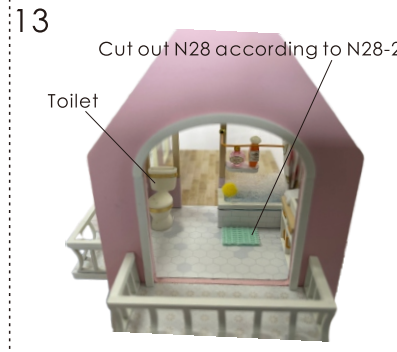
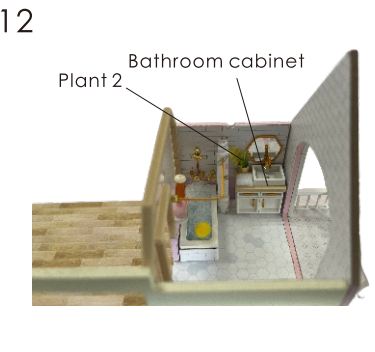
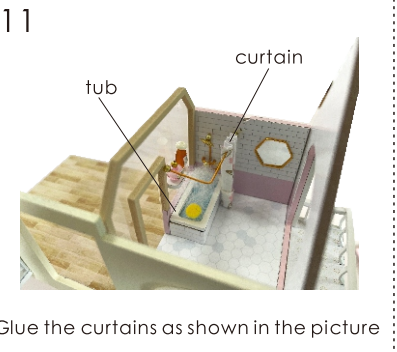
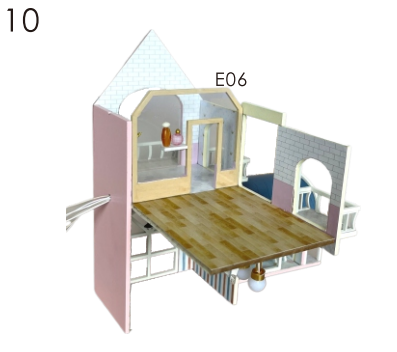
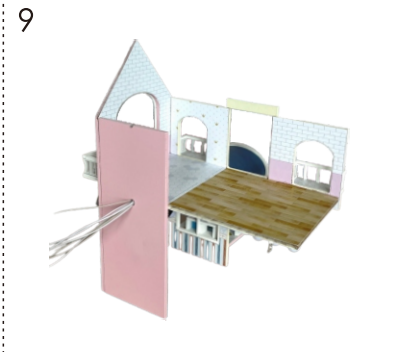
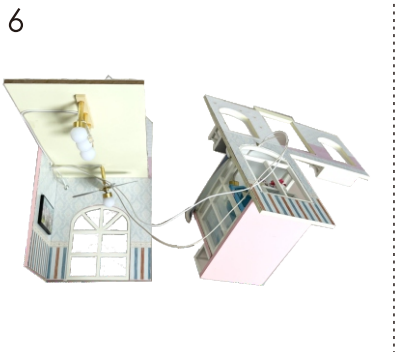
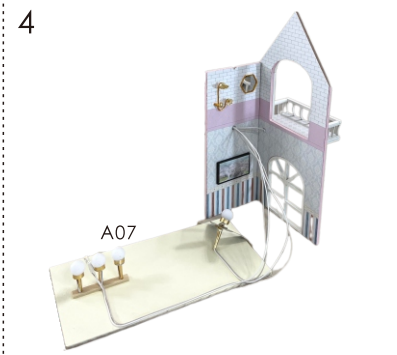
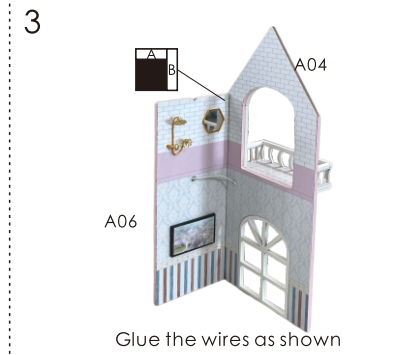
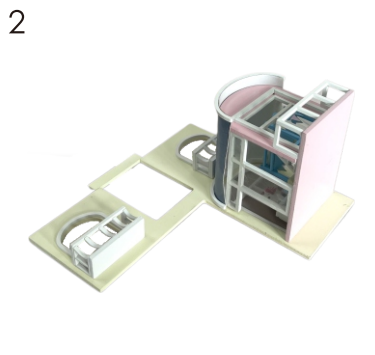

21

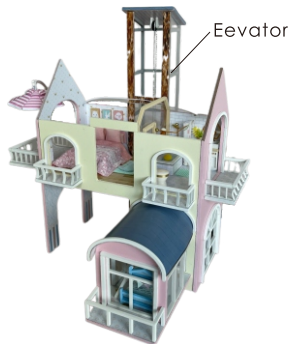

22



23



24



Glue the wires according to the red wire.

25



26

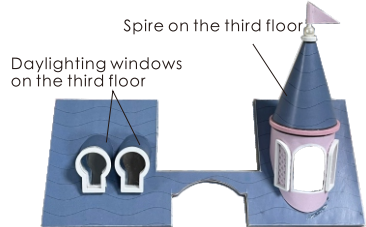

A18

27



28



29



30



31

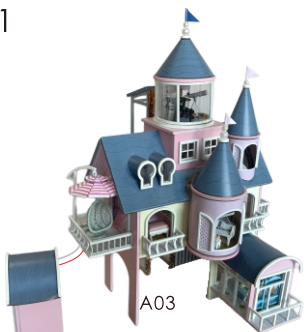

Pass the wire of the pet room through the panel A03

32



Glue the pet room and the wires at the same time as shown in the picture.

33



34



Glue the base

35



36

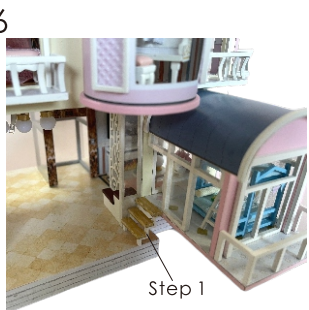

37

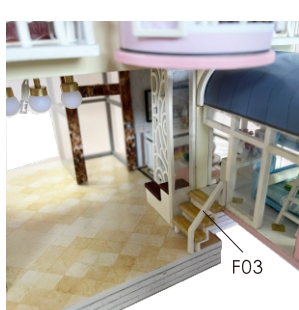

38



Gather the wires together as shown in the picture.

39

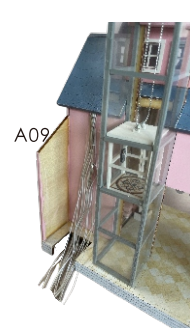

40



upgraded version  
(accessories need to be purchased separately)



P01 music movement  
(1 piece)



P02 movement handle  
(1 piece)



P03 movement screws  
(3 pieces)

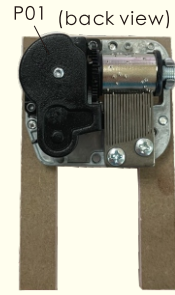
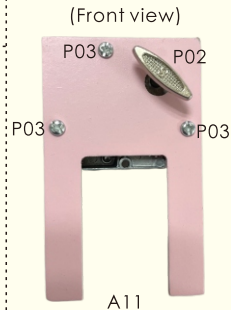

41

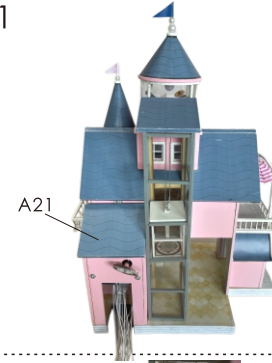

42



43



44

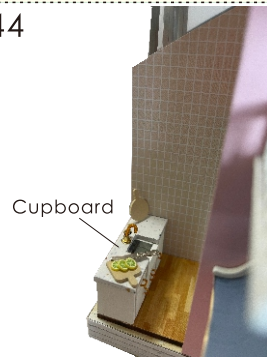

45

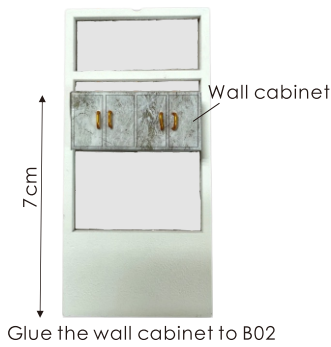

46



47



48



49



50



51



52



53



54

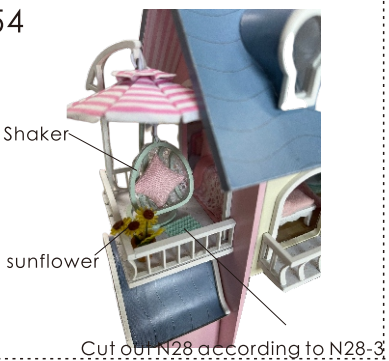

55



56



57



58



Cut out M24 according to template paper M24-1

Cut out M24 according to template paper M24-2

59



R08 R08 R08 R08 R08 R08 R08  
Cut R08 as shown, and then glue the top



Cut R09 in half

60



Glue R08, R09, R10 and R11 as shown in the picture

61



Cut the bottom of R12 flat

62



63



R13

65



R09

66



R11

R10

67



Swing

Step 2

68



balloon

69



Rocking horse

70



Plant

Dining chair

71



R08

72



R07

Cut off the plastic of R07 as shown in the picture

73



74



Glue the flower to the position on the picture

75



Glue the flower to the position on the picture

76



Slide

77



Seesaw

balloon

78



Slide

Lifebuoy

79



F15

F17

P22

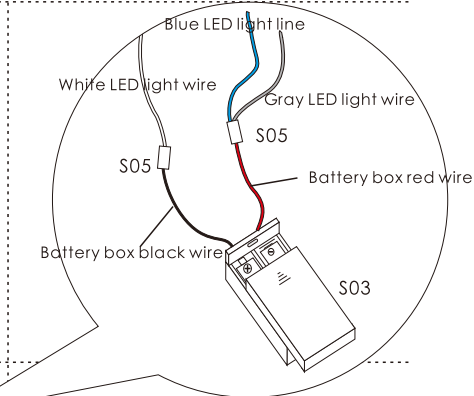
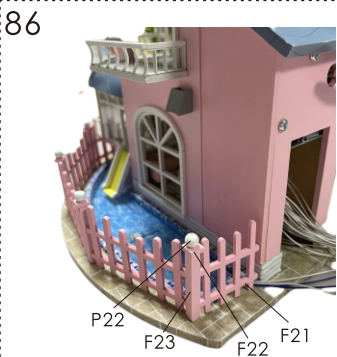

**How to assemble the battery holder**

Statement: the lamp wires cannot be inserted into the output socket.

- Can use 2\*AAA batteries
- Please notice the place of anode and cathode when put in the batteries
- Rechargeable batteries are not blunt electricity
- Rechargeable batteries can only be charged under adult supervision
- Rechargeable batteries should be removed from the toy before charging
- Different types of batteries cannot mix;
- Do not mix new batteries in use with semi-used batteries.
- Run out of battery should be removed from the toy
- The power shall not be short circuit



Cut the led light cord to the same length, then peel off the film, and twist the cords of the same color together



Connect the red wire of the battery box with the gray wire of the led light and the blue wire, and the black wire of the battery box with the white wire of the led light as shown in the picture

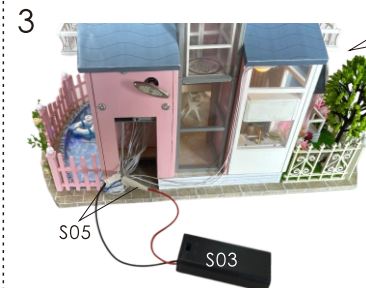

Connect the red wire of the battery box with the gray wire of the led light and the blue wire, and the black wire of the battery box with the white wire of the led light as shown in the picture



# Installation of dust cover

dust cover  
(Upgrade version accessories need to be purchased separately)



scale:1:12  
Z01 plexiglass (transparent)  
31.4\*27\*0.18(1piece)

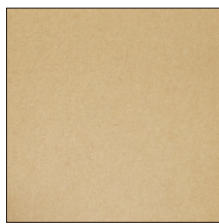

scale:1:12  
Z02 plexiglass (transparent)  
34\*31.4\*0.18(2pieces)

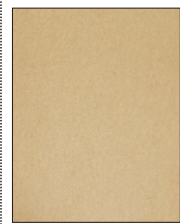

scale:1:12  
Z03 plexiglass (transparent)  
34\*26.64\*0.18(2pieces)



scale:1:12  
Z04 MDF(white)  
31.4\*27\*0.5(1piece)

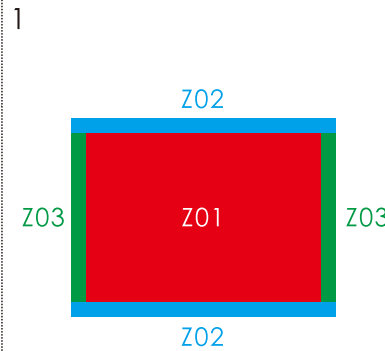

stick Z02 and Z03 on Z01

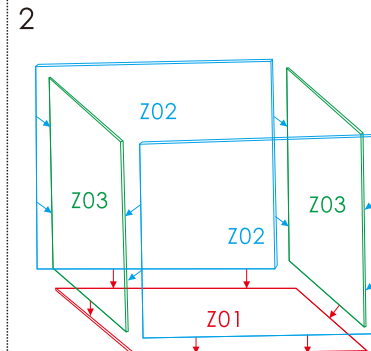

stick five pieces of plexiglass dust cover as shown



Ripped one side of kraft paper, leaving one side of kraft paper  
Take out the plexiglass and tear off the kraft paper with text on each piece of plexiglass

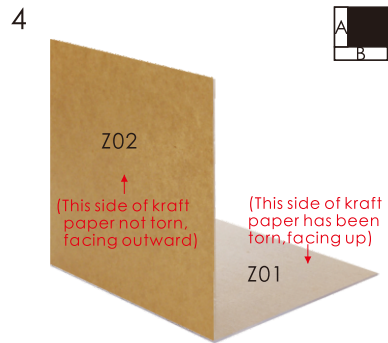

The kraft paper that has been ripped off faces inwards, and the kraft paper that has not been ripped out faces outwards.

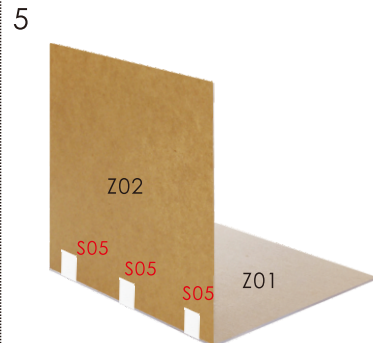

Use S05 to fix the junction of two pieces of plexiglass. (use transparent tape to replace L04)

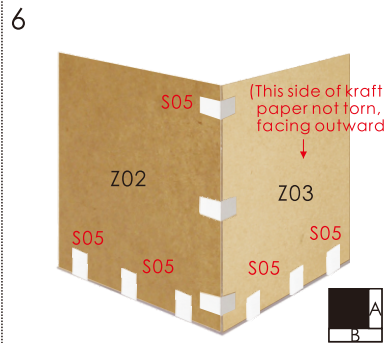

The junction of every two pieces of plexiglass needs to be fixed with S05 (to prevent the plexiglass falling off)

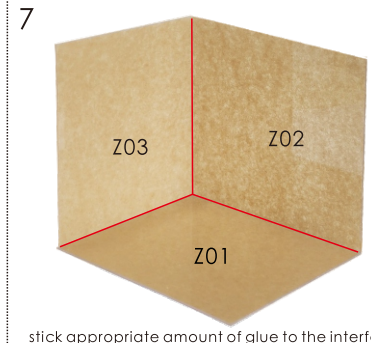

stick appropriate amount of glue to the interface of the two pieces of glass and scrape it slightly to make the glue penetrate into the junction of the two pieces of glass (the red line is the plexiglass interface)

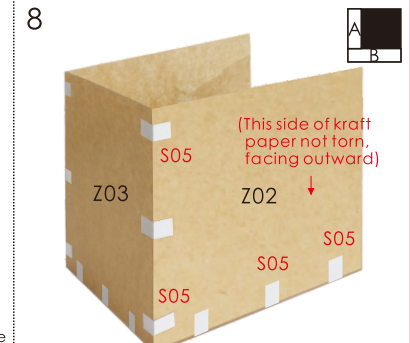

The junction of two pieces of plexiglass needs to be fixed with S05 (to prevent the plexiglass falling off)

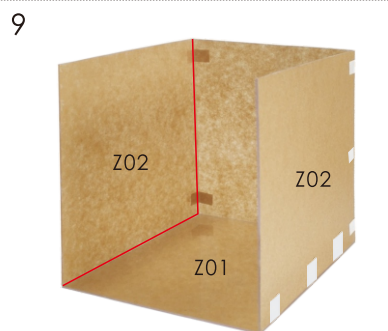

stick appropriate amount of glue to the interface of the two pieces of glass and scrape it slightly to make the glue penetrate into the junction of the two pieces of glass (the red line is the plexiglass interface)

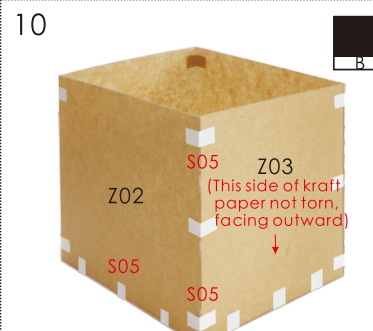

The junction of two pieces of plexiglass needs to be fixed with L04 (to prevent the plexiglass falling off)

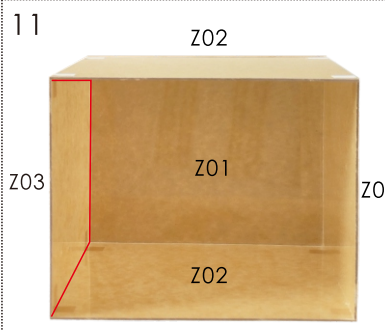

stick appropriate amount of glue to the interface of the two pieces of glass and scrape it slightly to make the glue penetrate into the junction of the two pieces of glass (the red line is the plexiglass interface)

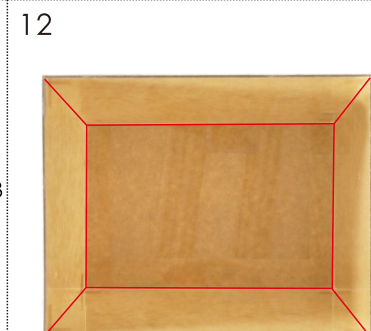

the dust cover need to be glued 8 interfaces

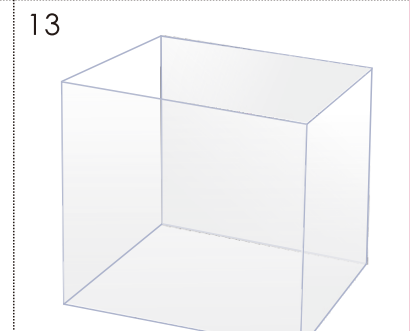

Leave it for 1 hour. After the glue dries out, tear off a layer of kraft paper outside the plexiglass

The instruction manual should be kept, after assembled