

K-034

# Pink cafe

DIY Dollhouse



ASSEMBLE TOYS

# TIPS

- 1.The picture of the package is the finished, please refer to it
- 2.Please prepare tools:ruler, knife, needle,scissors,tweezers etc
- 3.Please follow the template to cut for avoid material loss.
- 4.Please understand for various batches of materials have a small deviation
- 5.Parents must accompany the children to assemble the DIY doll house
- 6.If you find the wood crude,please use the sandpaper to make it better
- 7.Refer to the following picture to test the lamp whether can work normally
- 8.Refer to the following steps to connect the batteries with the battery box
- 9.Refer to the following steps to put button battery into the power supply device

## LED light Connect the extension wire

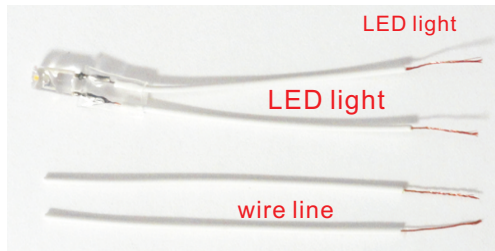

1. need 2 same long power wires to connect the extension wire

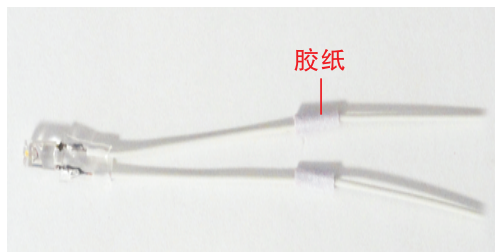

3.connect the light wire with the power wire

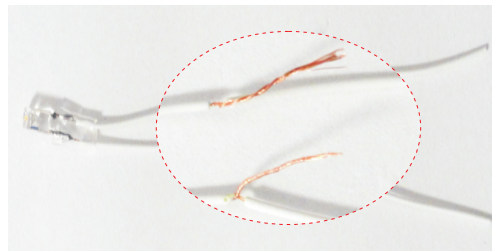

2.To strip the rubber 1cm from one side of the power wire

## Battery box installation method

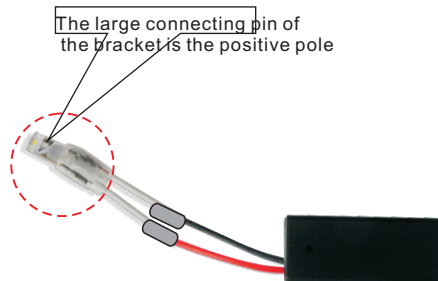

## Number the wood before making it



Take out the wood 1:1 checklist as shown in the figure; then take out the timber installation checklist from the wood package and give the wood number

Eg:



Tip: When you number the board, you must use a pencil to erase the number when you need to paste the wood.

# First floor decoration parts

Unit:cm

## 1. Wine cabinet making steps

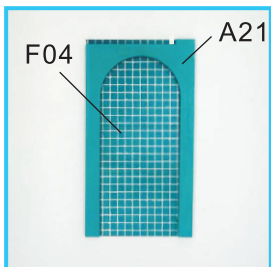

1.As shown paste

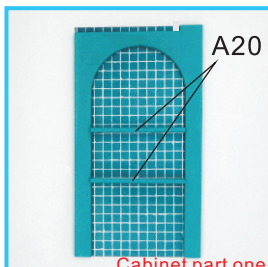

Cabinet part one

2.As shown paste the wine cabinet finish the part one



3.As shown paste



Wine bottle part two

4.As shown paste the wine bottle part 2

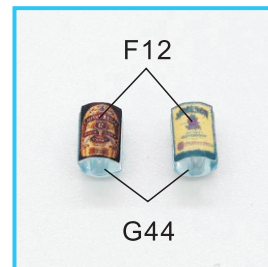

G44

5.As shown paste



Wine bottle part three

6.As shown paste the Wine bottle part three

G10(length:0.8 cm)

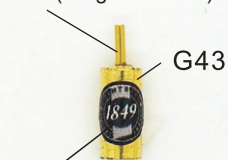

Wine bottle part four

7.As shown paste finish the wine bottle part four

G17 card paper



Paste the F17 against the edge, and then use the G-017 jam.

8.As shown paste cut off F17

F17



9.Cut off F17

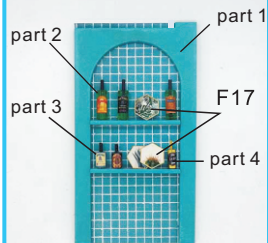

10.As shown paste it

## 2. Cashier making steps

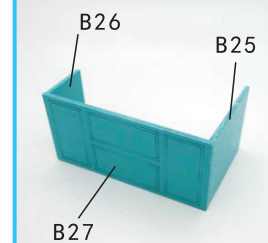

1. As shown paste

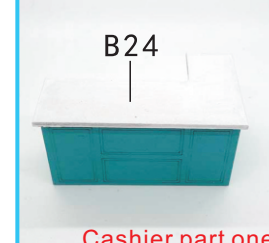

Cashier part one

2.As shown paste finish the cashier part one

F36



C18

3.As shown paste the F36 print paper into the wooden C18

C18

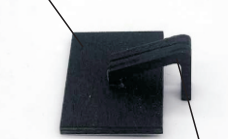

Cashier part two

C19

4.As shown paste the cashier part two

F22



5.Cutting F22 two pcs , fold and paste it



6 .As shown paste F12

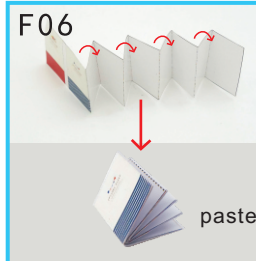

paste

7. Cut F06 as shown fold and paste it



As shown paste

8. total finish the F05,F06 two books

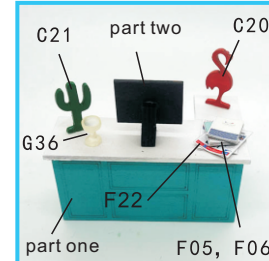

part one

F05, F06

9.As shown paste the part

## 3. Swimming pool table making steps

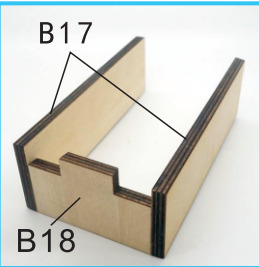
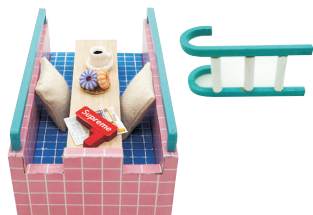

1.As shown paste

F37

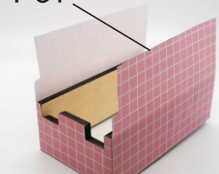

Fold and paste according to the F37 dotted line

2.cut F37 as shown paste

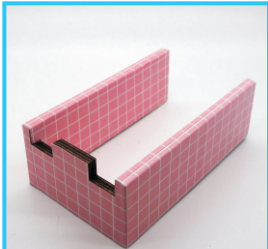

3.As shown paste and fold it

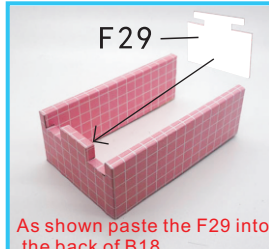

As shown paste the F29 into the back of B18

4.Cut F29 as shown paste

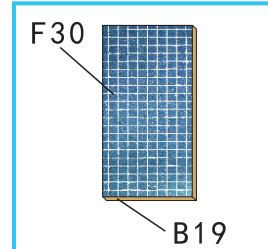

B19

5. Cut F30 print paper as shown paste into B19 wooden

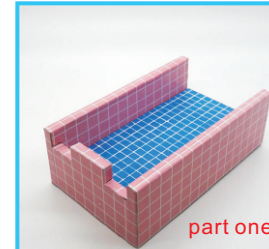

part one

6.As shown paste the swimming pool finish part one

First floor decoration parts

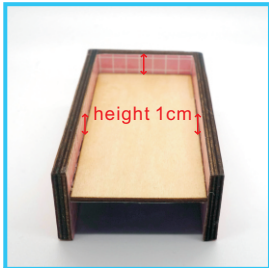

7. the back of part reference

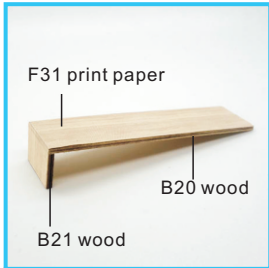

8. As shown paste

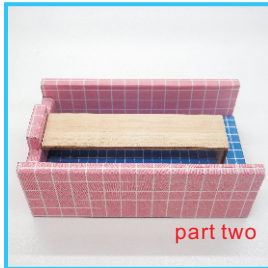

9. As shown paste into part one and finish part two

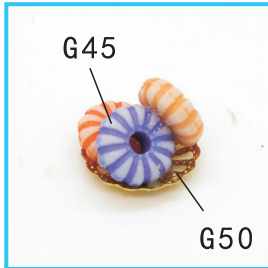

10. As shown paste



11. As shown paste fold

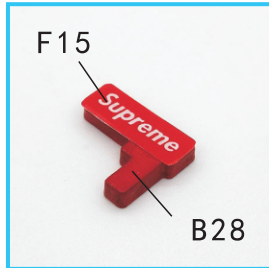

12. cut F15 print paper then paste into B28

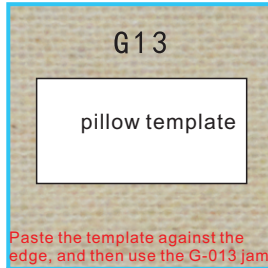

13. As shown pillow template 1size to cut G13  
Paste the template against the edge, and then use the G-013 jam.

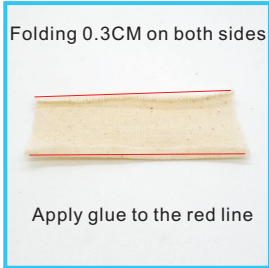

14. As shown fold G-013



15. As shown paste

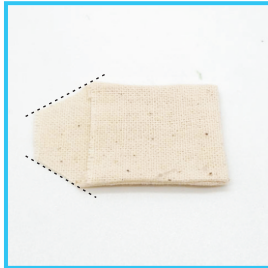

16. As shown to cut

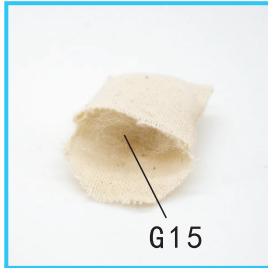

17. Fill in cotton



18. As shown in the figure  
Finish the 2pcs

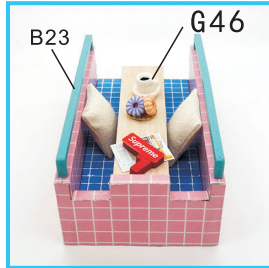

19. As shown paste accessories into part two

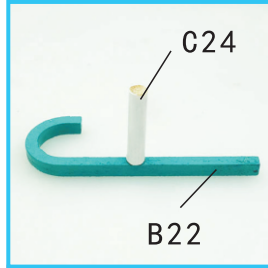

20. As shown paste (C24aligned B22 center)



22. As shown paste 2pcs

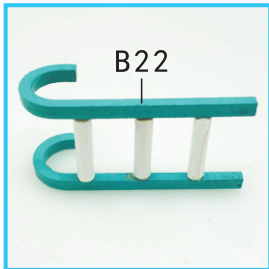

23. As shown finish the Escalators



4. Dining chair making steps

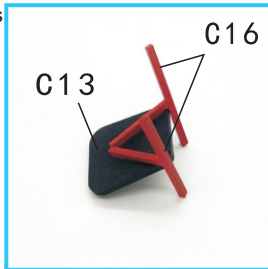

1. As shown paste

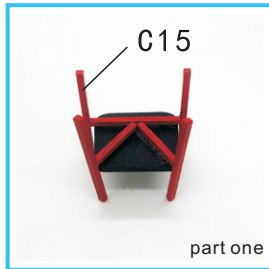

2. As shown paste the part one

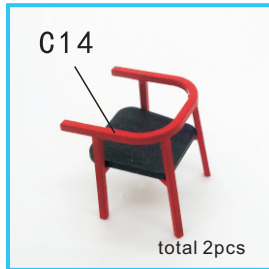

3. As shown paste  
total 2pcs



5. Table making step

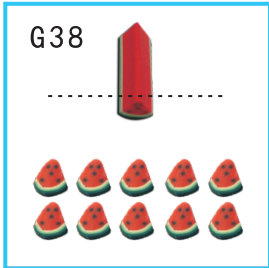

1. Cut 10 pcs along the dotted line

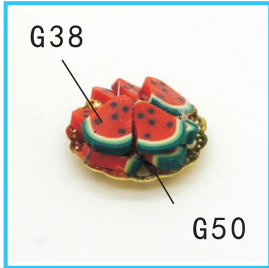

2. As shown paste, finish the Fruit tray

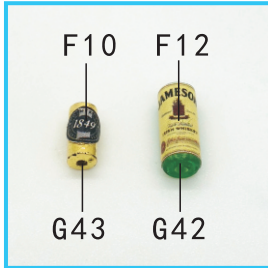

3. As shown paste

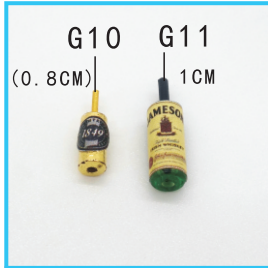

4. As shown paste, finish the bottle

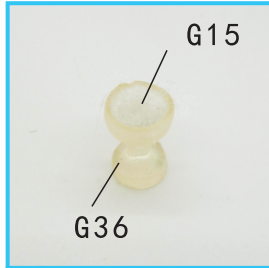

5. As shown to paste the cotton

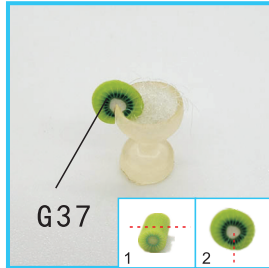

6. G-037 is cut by the dotted line and pasted to G-036

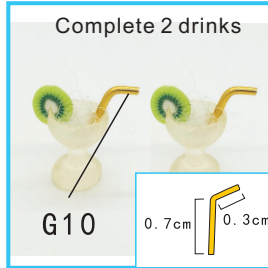

7. G10 as shown bending to paste into G-036, finish the drink

# First floor decoration parts

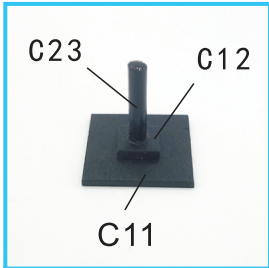

8.As shown paste

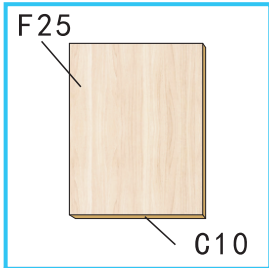

9.As shown paste



10.As shown paste



11.Paste G-014 lace edge



12.Paste fruit plate



13.Paste the wine bottle



14.Paste the drinks

## 6. Potted plants, rack production



1.Cut G-013 linen according to the template

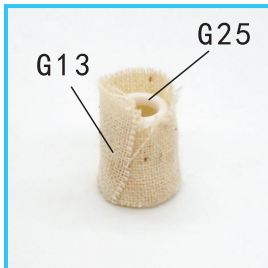

2.As shown paste



3.Cut off the excess linen

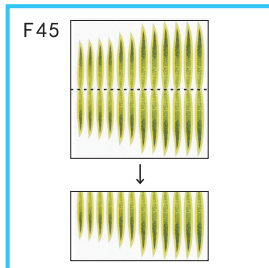

4.Crop F45 and paste it along the dotted line



5.Crop out all the leaves as shown



6.Choose the longest leaf to paste



7.Paste the remaining leaves as shown



8.Bend the leaves as shown

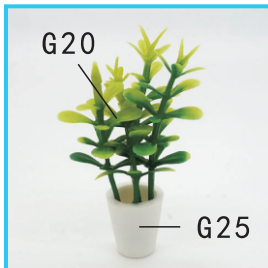

9.As shown paste

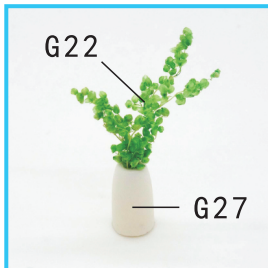

10.As shown paste

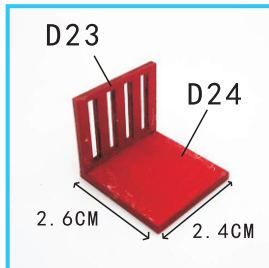

11.The back of shelf as shown paste

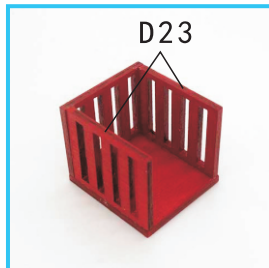

12.The back of shelf as shown paste

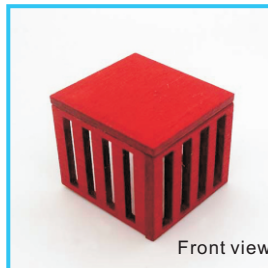

13.finish the shelf

## 7.Decorative ladder making

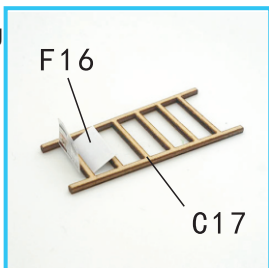

1.As shown fold F16

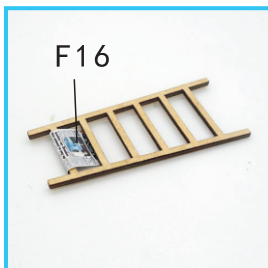

2.As shown paste F16

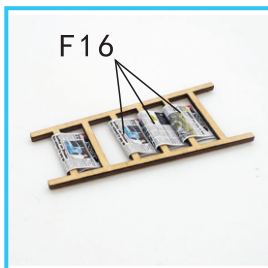

3.As shown paste F16, finish the ladder

## 8.Waiting chair production

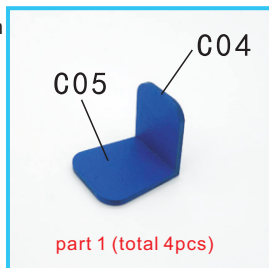

1.As shown paste, finish the part 1

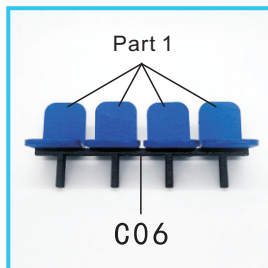

2.As shown paste

# First floor decoration parts

## 8. Floor lamp making step



G48  
G26

1.As shown paste

G49

2.As shown paste

G51

3.As shown paste

G11 (1. 4CM)

4.As shown finish the floor lamp

## 9.Orchid making steps

G21(2pcs)  
G25

1.As shown paste the Orchid

## 10.Sofa making steps



C02  
C03

1.As shown paste

2.The back reference

C01

3.Paste the C01 finish the Sofa

## 11.Turtle leaves potted



1.As shown cut into F19

9cm  
9cm  
7cm  
4cm

2.As shown to cut G09 line about 4pcs

G09  
F19

3.As shown paste

1  
2  
3  
4

4.As shown paste F19 into G09

1  
2  
3

5.Winding the wire 1, 2, 3 as shown

4

6.Wind the wire 6 as shown

Turtle Leaf Parts 1

7.As shown fold finish the part 1

G-013 sackcloth

Flowerpot cloth template

8.As shown template to cut G13

G13  
G25

9.As shown paste

part 2

10.Cuting extra sackcloth to finish the part 2

part 1  
G-024 sand  
part 2

11.As shown paste the part

12.As shown bending part 1 to finish Turtle leaf pot

## 11.Blue lotus pot making

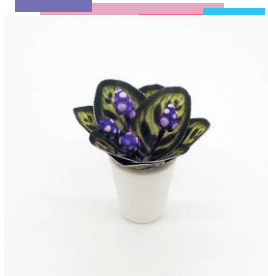

F44

1.As shown cut F44 and fold and paste along the dotted line

2.Figure F44 cut out as shown

F44  
G25

3.Select the maximum 4 l eaves, as shown

# First floor decoration parts



4. Paste the remaining leaves as shown, Finish part 1



5. As shown take out the G39 fold, Cut off along the dotted line



6. 如图将G39粘贴到部件1完成蓝莲花盆栽

## 12. Storefront and wall lamp 1



① with LED light



1. take out the G07 light as shown to bend it



2. As shown use G07 through G40 and paste it



3. As shown use G07 through G48 and paste it



4. As shown use G07 through G51 and paste it, finish the part 1

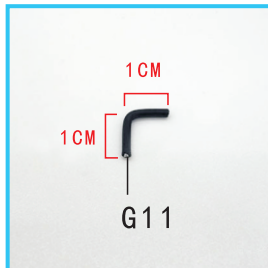

5. cut out G11 and bend it as shown



6. As shown paste G11 into the part 1, finish the wall lamp

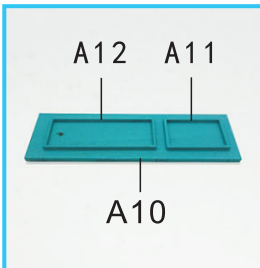

7. As shown paste

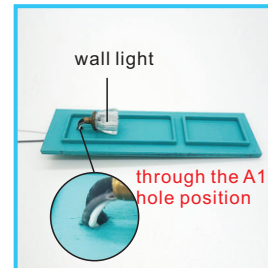

8. As shown use G07 through A10 hole and paste it

## 13. Storefront and wall lamp 2

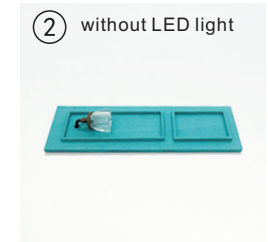

② without LED light



1. As shown paste



2. As shown paste, finish the wall lamp part 1

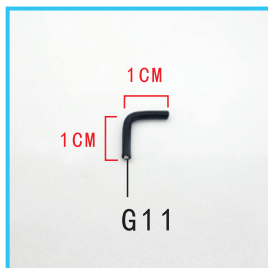

3. cut out G11 and as shown to bend it



4. As shown paste G11 into part 1, finish the wall lamp

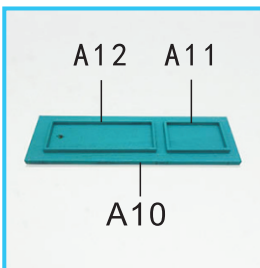

5. As shown paste

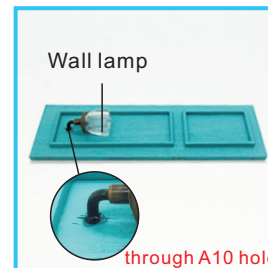

6. As shown paste the wall lamp

If the G11 wire of the wall lamp has a convex shape, please cut it flat.

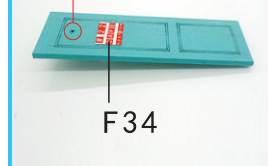

6. As shown paste F34

## 14. Stair making steps

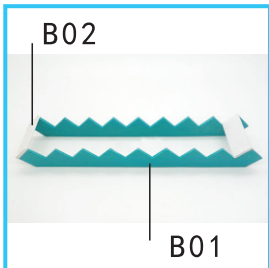
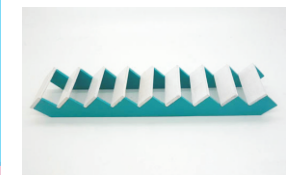

1. As shown paste

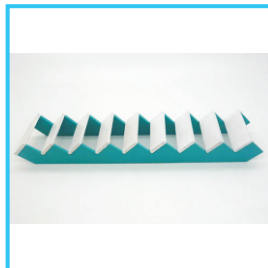

2. Then paste the remaining 7 pieces of B02 as shown.

## 15. Decorative painting



1. refer to F38/39 dotted line into C07

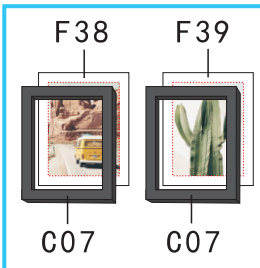

1. refer to F38/39 dotted line into C07



2. As shown paste F41/F43 into C08 and C09

## 16. Picture frame production



1. As shown paste F40 into G17 and Cut out along the red dotted line

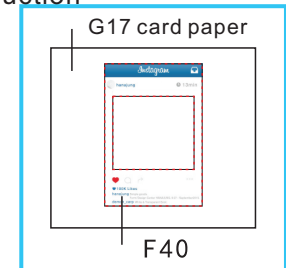

1. As shown paste F40 into G17 and Cut out along the red dotted line

Second floor decoration parts

1. Counter making step

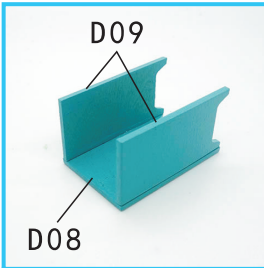

1.As shown paste



2.As shown paste ,finish the part 1



3.As shown paste ,finish the wall lamp

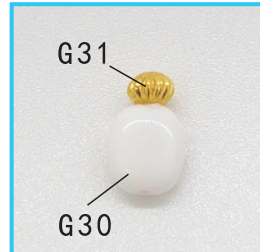

4.As shown paste ,finish perfume bottle 1

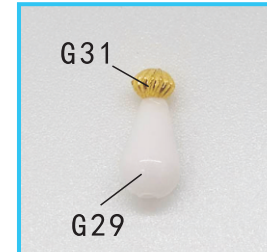

5.As shown paste, finish the perfume bottle 2



6.finish part as shown paste

2. Table making step

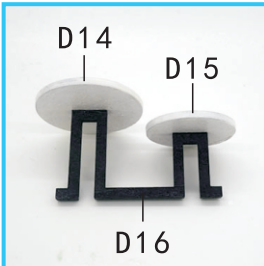

1.As shown paste

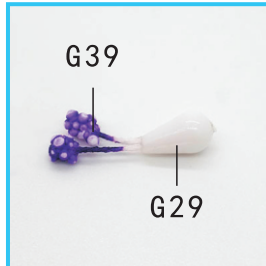

2.As shown paste



3.As shown paste, finish the vase



4.as shown paste the part.

3. Skateboard making steps

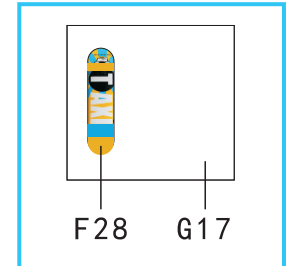

1.Take out F28 paste into G17



2.cut out and the back paste into F28



3.Bend the sides as shown , finish part 1



4.As shown cut out paste into G52,finish the skateboard wheel



5.finish two skateboard wheels



6.As shown paste skateboard wheel into part 1

4. Stool making steps

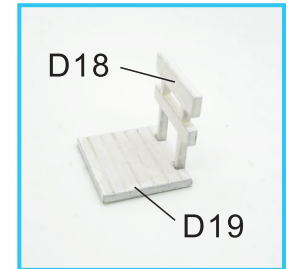

1.As shown paste the backrest

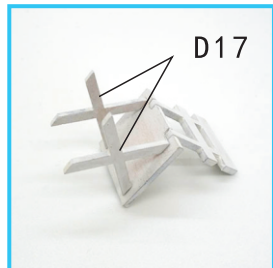

2.paste D17 finish the chair foot



3.finish the second chair

5. Bar chair making steps

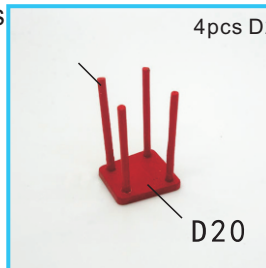

1.As show paste ,finish the bar chair

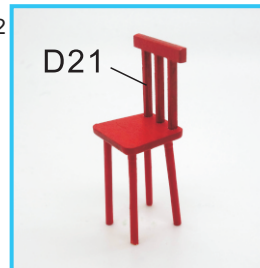

2.As shown paste the Chair



3.Finish the second bar chair

6. Second floor decorative painting production

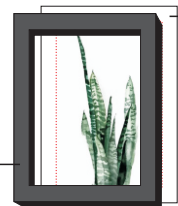

B12

F42



## Second floor decoration parts

### 6. Book box making steps

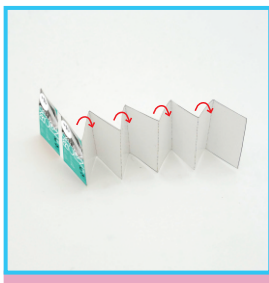

1. cutting F18 as shown fold it



2. As shown paste F18



3. As shown paste F18 total three books

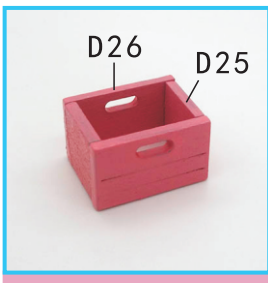

4. As shown paste the bookcase



5. As shown paste the books into bookcase

### 7. Bar making steps

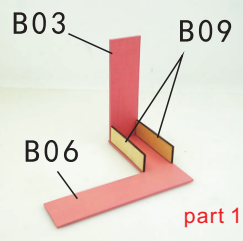
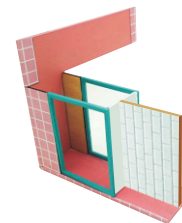

1. As shown paste ,finish part 1

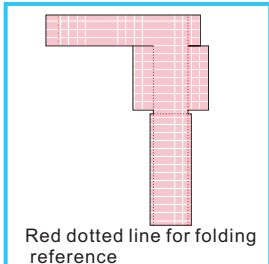

2. As shown cut out F24  
Red dotted line for folding reference

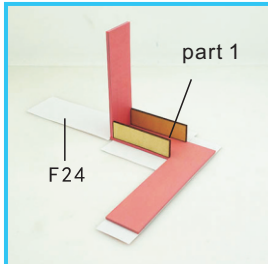

3. As shown paste F24 into part 1

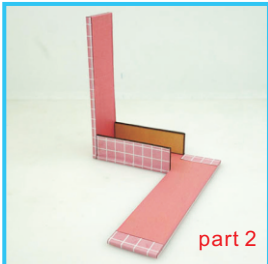

4. As shown paste ,finish part 2 (Fold and paste according to the red dotted line)

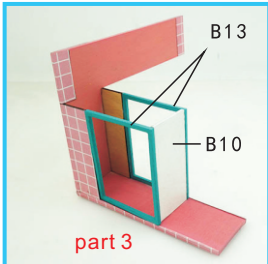

5. As show paste in part 2 and finish part 3,

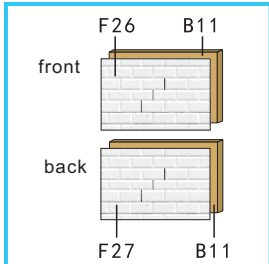

6. As shown paste F26/F27 into B11 front

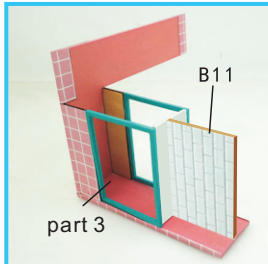

7. As shown paste in part 3, finish the Bar

### 8. 吧台装饰制作

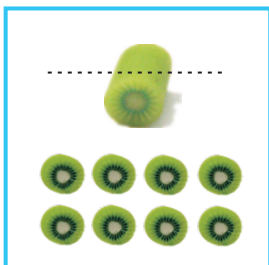

1. Cut 8 pcs along the dotted line

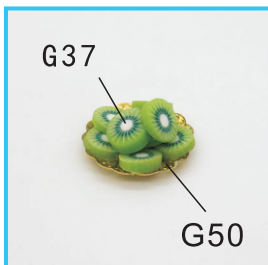

2. As shown paste to finish the fruit dish

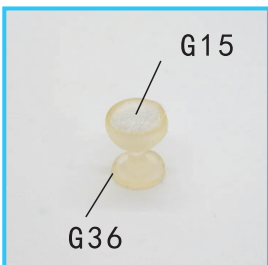

As shown paste the cotton

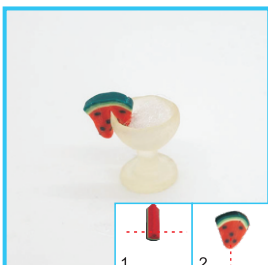

4. G018 is cut by the dotted line and pasted to G36

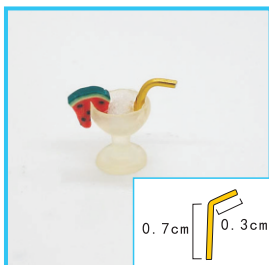

5. As shown bending G10 and paste into G36, finish the drink

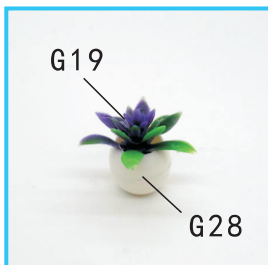

6. As shown paste and finish the fleshy pot

### 9. Bar decoration making



1. Take the G16 non-woven fabric and cut it according to the size of D11.



2. take out G12 sofa template size to cut



3. cut out G12 as shown paste



4. Paste the four sides and the four corners as shown



5. As shown cut off the four corners



6. Paste the four sides to finish the part 2

## Second floor decoration parts



7. Cut and paste G17 according to part 2 size

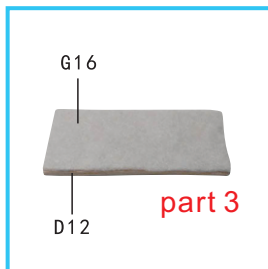

8. Take out G16 no-woven cloth and cut it according to the D12



9. take out G12 cut it according to the sofa template 3



10. take out G12 and as shown paste it



11. As shown paste four sides and corners



12. As shown to cut four corners



13. paste four sides and finish part 4



14. cut G12 one pc according to part 4 size

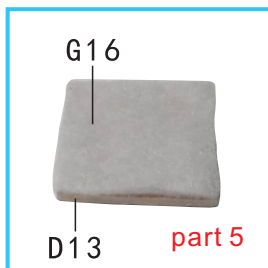

15. take out G16 no-woven cloth according to D13 size



16. take out G12 according to sofa template 2 size



17. cut out G12 as shown paste



18. as shown paste four sides and corners



19. Cut four corners, and as shown paste, finished part 6



20. Cut G12 one pc according to part 6 size



21. As shown to finish two sofa sides

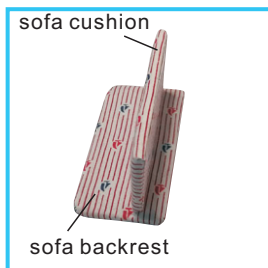

22. As shown paste

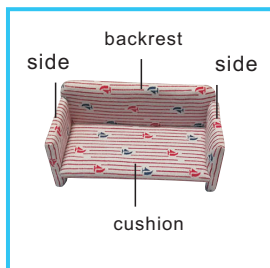

23. As shown paste to finish sofa

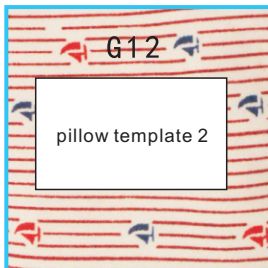

24. take out G12 according to pillow template



25. cut out G12, as shown fold two sides



26. fold two sides and paste glue



27. As shown paste



28. As shown to cut the corner



(Tip: Cotton plugs will make a little more pillows)

29. As shown filling the cotton



30. As shown seal paste



31. as shown finish two pillows



32. As show paste to finish sofa

## Assembly first floor

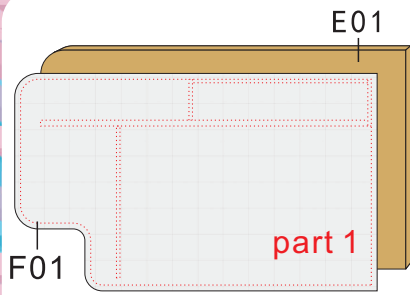

1. as shown paste F01 into E01, finish part 1  
(tip: paste print paper must use white glue)

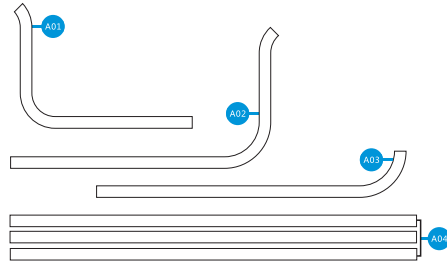

2. As shown take out the wood  
(tip: pasting is need to wood direction)

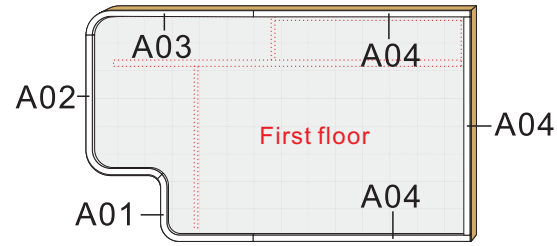

3. As shown paste wood into part 1, finish first floor  
(tip: The red dotted line is the wood paste position)

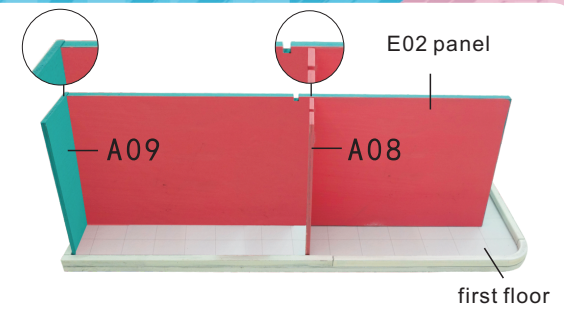

As shown , paste the red dotted line on the first floor.

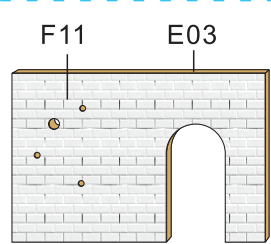

5. As show paste F11 into E03

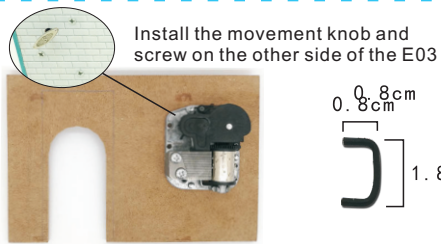

6. Install the movement as shown:  
E03 with F11 side mounted  
movement knob and screw

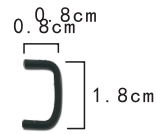

7. Cut G11 wire line 3.4 cm,  
As shown bend

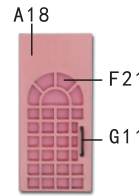

8. As shown paste,  
finish the doll component

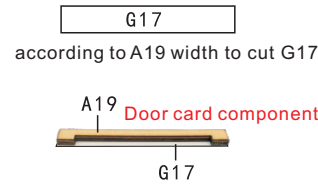

9. as shown paste A19 into  
**door component**

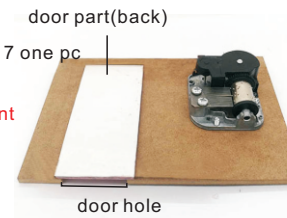

10. As shown put on E03  
(Align the door hole)  
**tip: The door can be put up, no glue sticking**

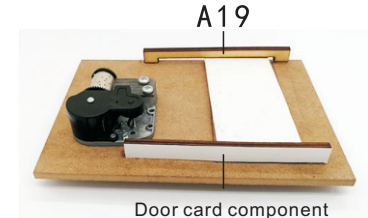

11. paste door component and A19

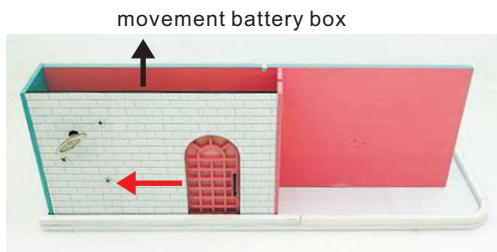

9. As shown paste ,finish battery box  
(tip: please don't pasting door, and can move to  
the red arrow)

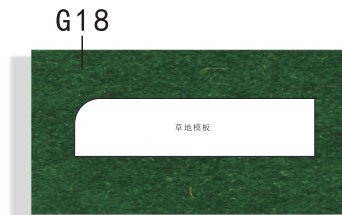

10. As shown, cut a piece of G18 simulation grass  
according to the size of the grass stencil printing paper.



11. As shown paste  
G18 into simulation grass



12. As shown paste finished first floor parts

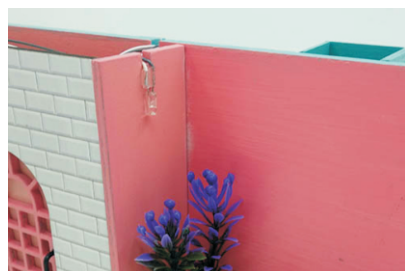

13. As shown, paste the G07 lamp into the A08 card slot,  
and the lamp cable is placed in the movement battery box.

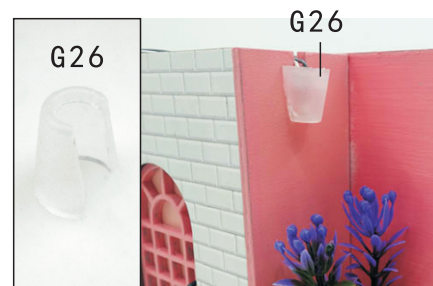

14. Cut the G26 in half, as shown paste



15. As shown paste first floor parts  
(store and wall light)  
(tip: the shown is the back of movements box)

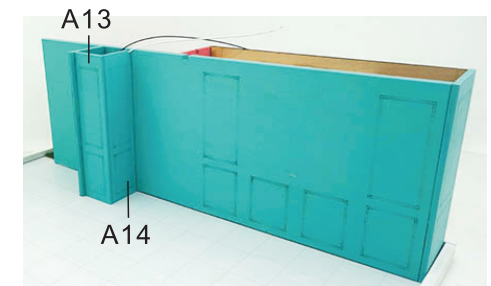

16. As shown paste A13, A14

## Assembly first floor

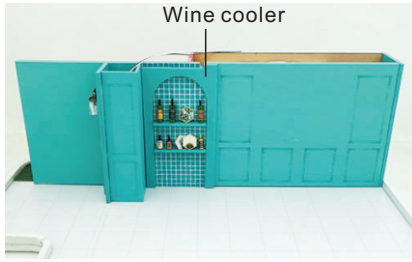

17. As shown paste the wine cooler

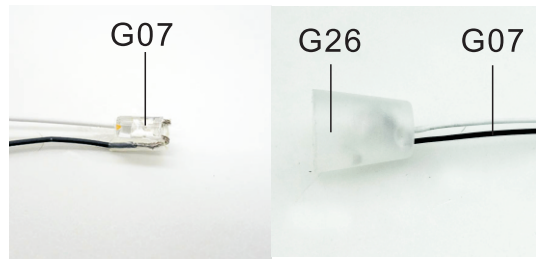

18. As shown fold G07 light and through G26, finish the chandelier



19. As shown paste the chandelier, and paste the wall light in the groove

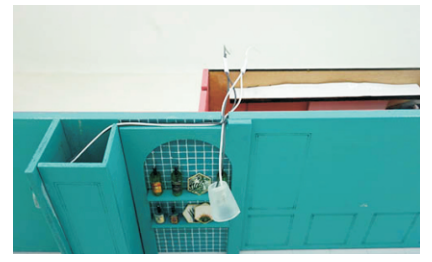

20. as shown connection chandelier and light line (Tip: gray and gray, white and white)



21. paste A15/storefront and wall light 2

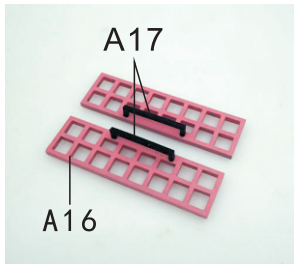

22. Paste A16/A17, as shown paste and finished the door



23. Paste the door as shown

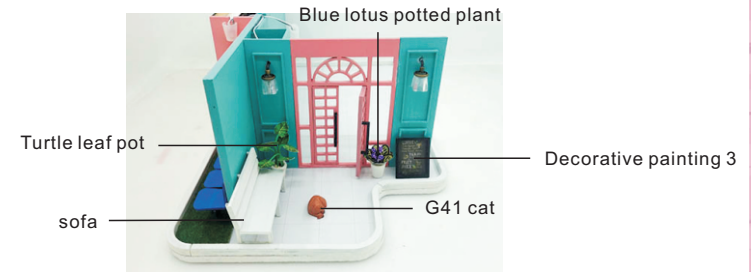

24. As shown paste finished first floor part



25. As shown, paste finished first floor parts



26. As shown paste pool table and escalators



27. As shown paste dinner table and chairs

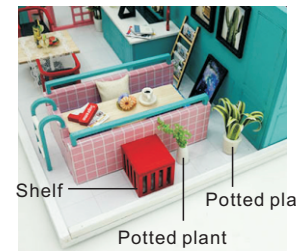

28. As shown paste potted plant, shelf



29. As shown paste the picture frame

## Assembly second floor



1. as shown paste to finish second floor

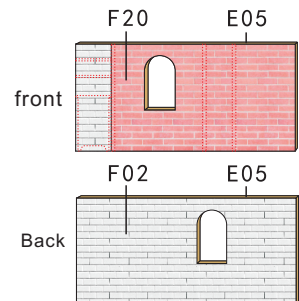

2. As shown paste F02/F20 into E05 both sides, finish second floor wall 1

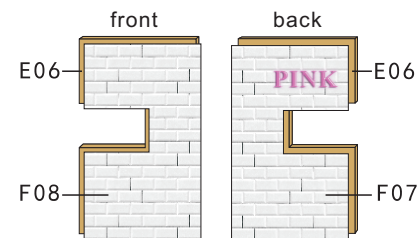

3. As shown paste F07/F08 into E06 to finish second floor wall 2

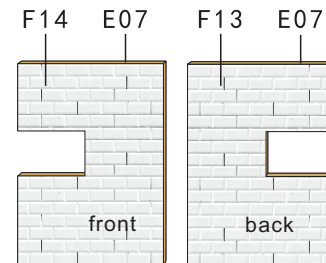

4. As shown paste F13/F14 into E07 to finish second wall 3

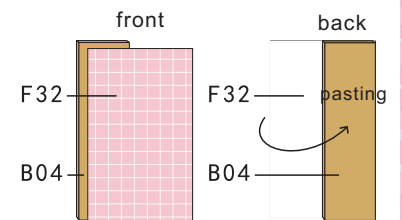

5. As shown paste F32 into B04, then fold F32 into the back of B04 and paste

## Assembly second floor

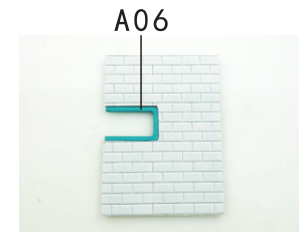
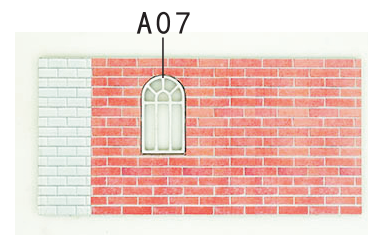
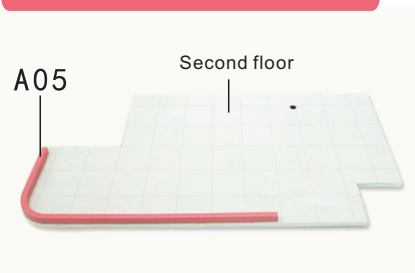
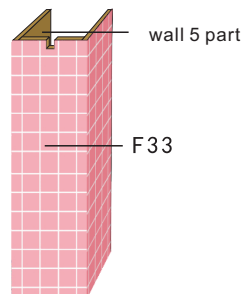
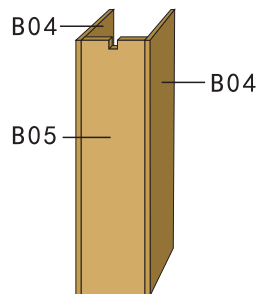
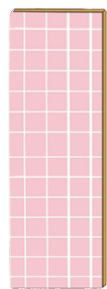

6.As shown ,second floor wall 4 finish making

7.As shown paste and finish second wall 5 part

8.As shown, paste F33 into wall 5 part, finish the second floor wall 5

9.As shown paste A05 into second floor

10.As shown paste A07 into second floor wall1

11.As shown paste A06 into wall 3 in second floor

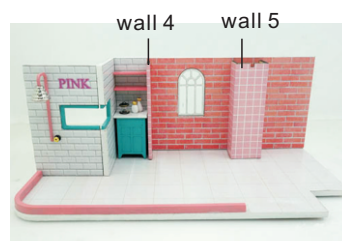
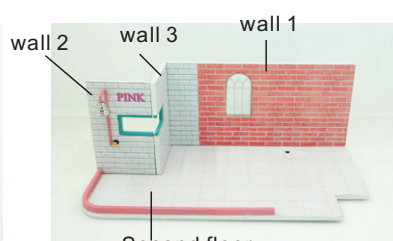
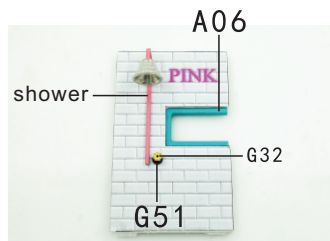
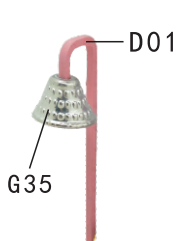

12.As shown to paste , finish the shower

13.As shown paste shower and other part into wall 2

14.As shown paste

15.As shown paste

16.As shown paste

17.As shown paste

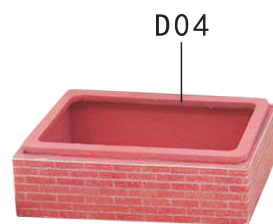
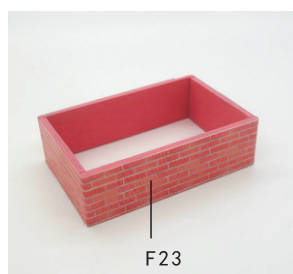
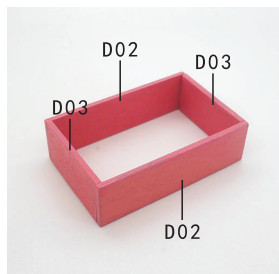

18.As shown paste

19.As shown paste

20.As shown paste, finish the bathtub

21.As shown paste the bathtub

22.As shown paste cotton

23.As shown paste

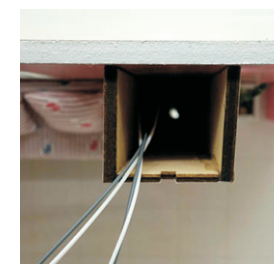
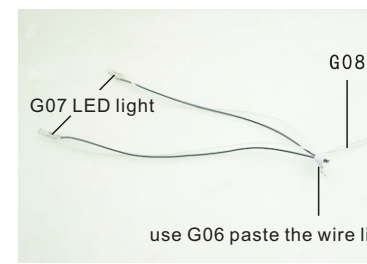
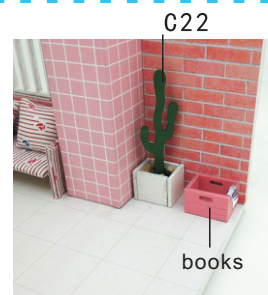
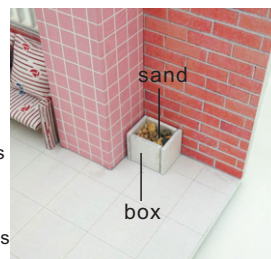
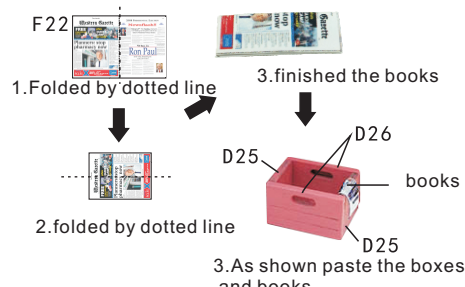

19.As shown paste the D27,finish the box

20.As shown paste the books

21.As shown paste the boxes into second floor and paste the sand

22.As shown paste

23.Connecting wire(Tip: Gray and gray , white and white)

24.As shown use LED light through second floor 's hole

# Assembly second floor



25. as shown paste the light line



26. As shown ,cut a slit by the dotted line

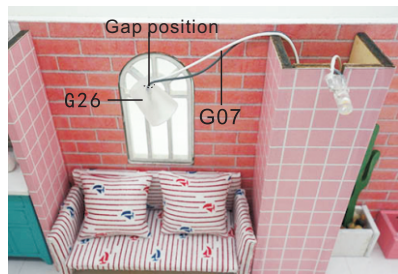

27. As shown paste G26 into G07, G06 gap position paste in G07 light line ,finish chandelier



28. As shown paste Bar counter



29. As shown paste the chandelier

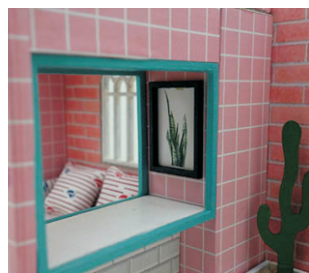

30. Paste the second floor decoration painting as shown



31. As shown paste Bar decoration

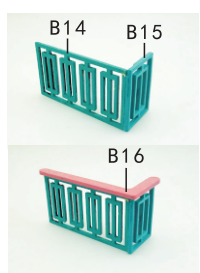

32. As shown paste the fence

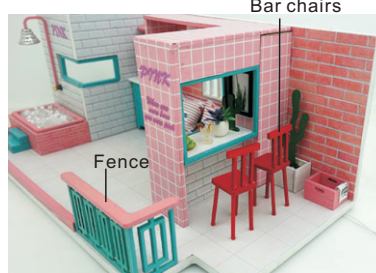

33. As shown paste the Fence, Bar chairs



34. As shown paste the skateboard, chairs



35. As shown paste books

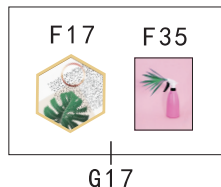

36. As shown paste the print paper into G17 then cut out it



36. As shown paste

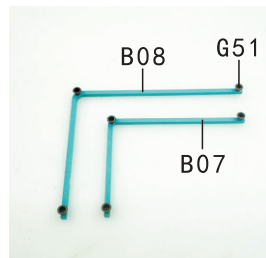

37. As shown paste



38. As shown paste

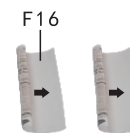

Roll up F16 as shown



39. As shown roll up F16 and paste in the book

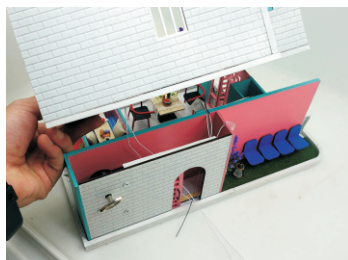

1. paste the first and second floors together as shown in the figure; Note: Put the wires into the movement box and paste them.



2. pasting position reference (Tip: second floor right side aligned with movement)

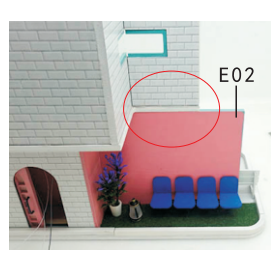

3. the pasting position reference (Tip: second floor back side aligned with E02)

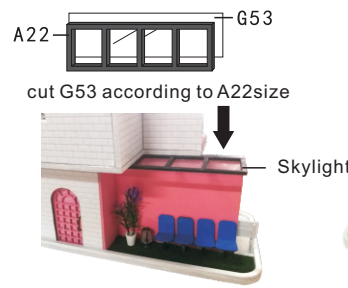

cut G53 according to A22size

Skylight

4. As shown paste the skylight



5. front position as refer



37. As shown paste stair

# Install dust cover

## Battery box installation



1. Strip the wire as shown in the figure: the positive electrode is connected to the positive electrode, and the negative electrode is connected to the negative electrode.

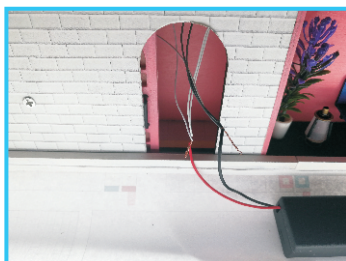

1. Connect the connected wires to the battery box as shown in the figure, the positive pole of the wire is connected to the positive pole of the battery case, and the negative pole is connected to the negative pole.



3. Wrap the wire with G06 wood grain paper as shown



4. As shown, the battery box is hidden in the battery compartment of the movement.

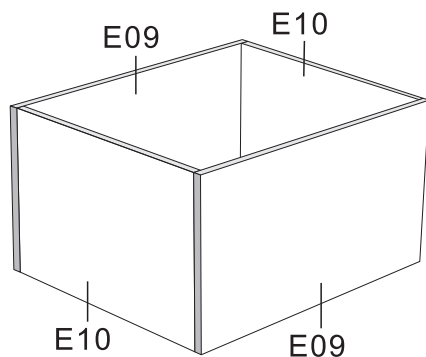

First step

paste E09,E10

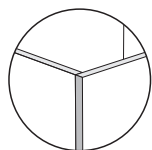

Pay attention to the thickness when pasting

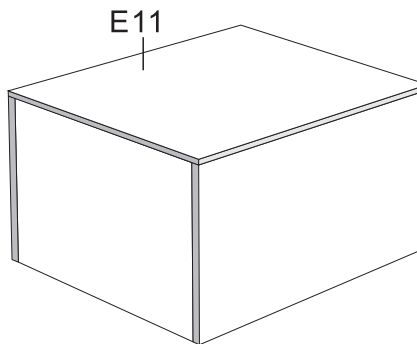

Second step

paste the E11 to the top layer and finish the dust cover.

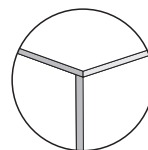

Pay attention to the thickness when pasting

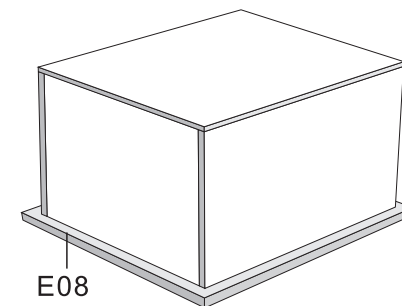

Third step

Cover the dust cover to the E08 panel Complete the dust cover

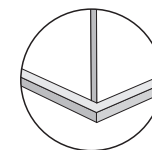

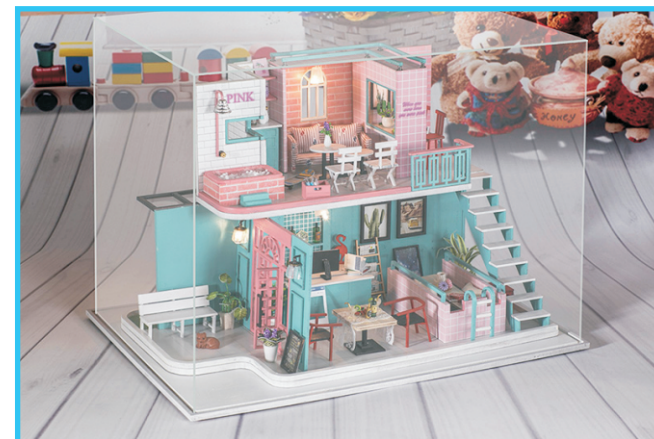

When covering the cover, pay attention to the thickness of 0.5Cm on the four sides of the panel.

## Completed picture

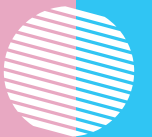

# ASSEMBLE TOYS



 **WARNING:**  
CHOKING HAZARD - small parts,  
Not for children under 14 years.





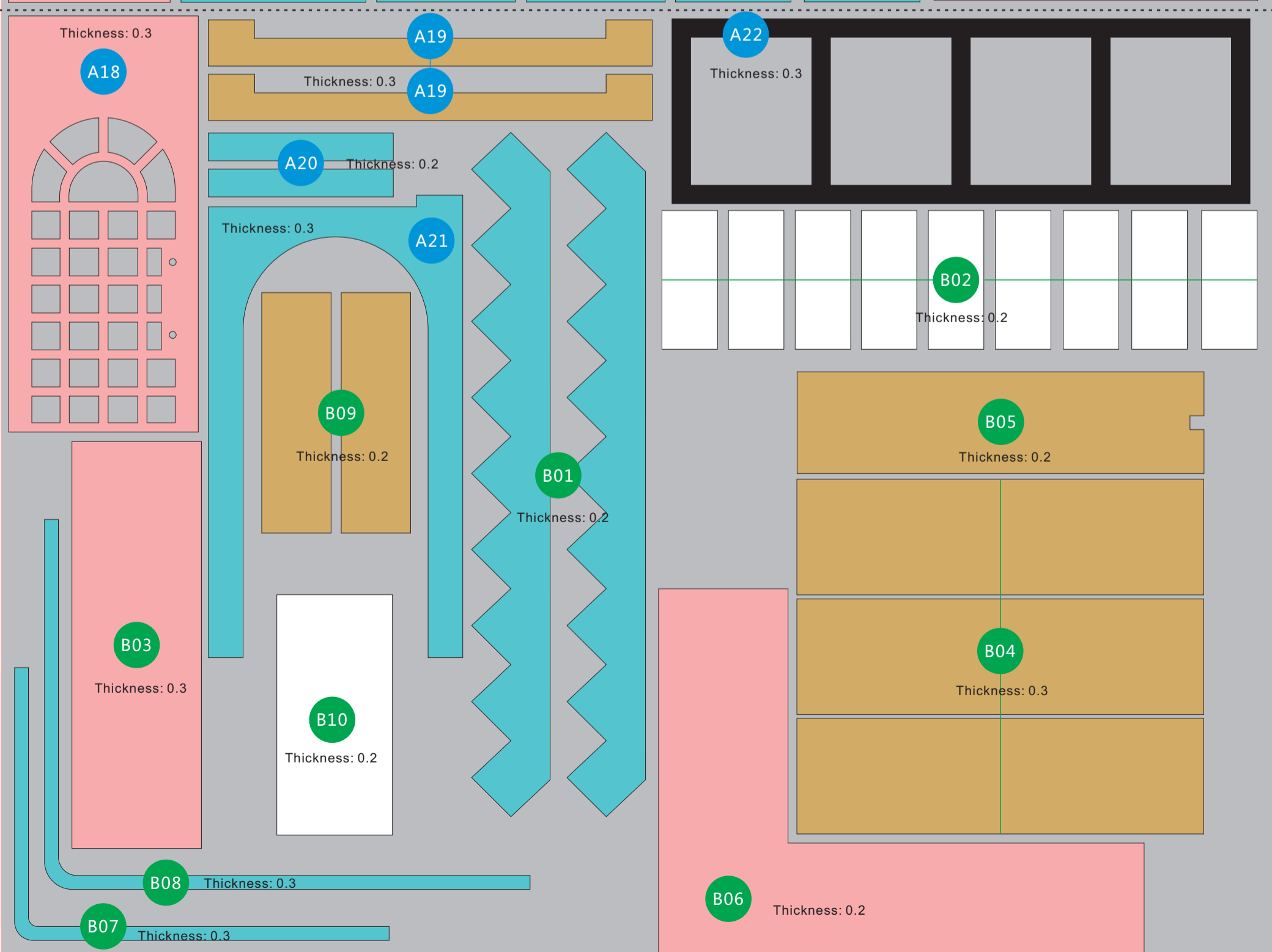
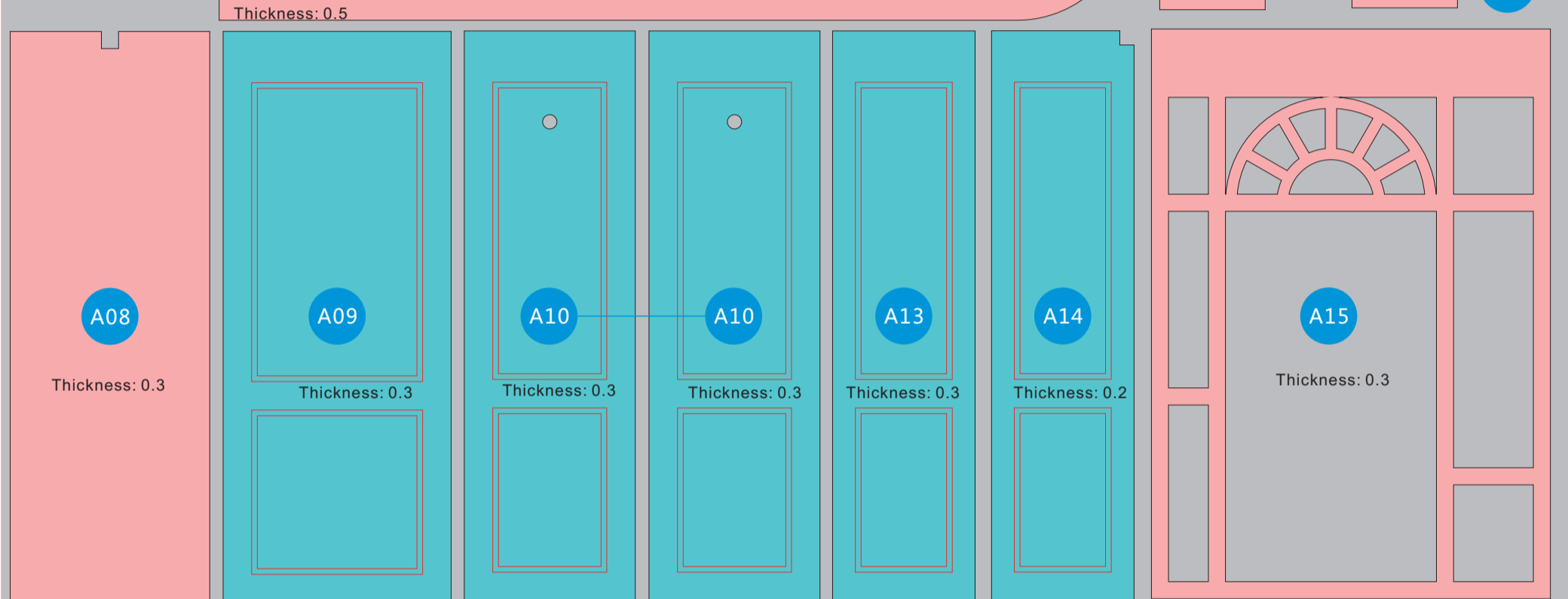
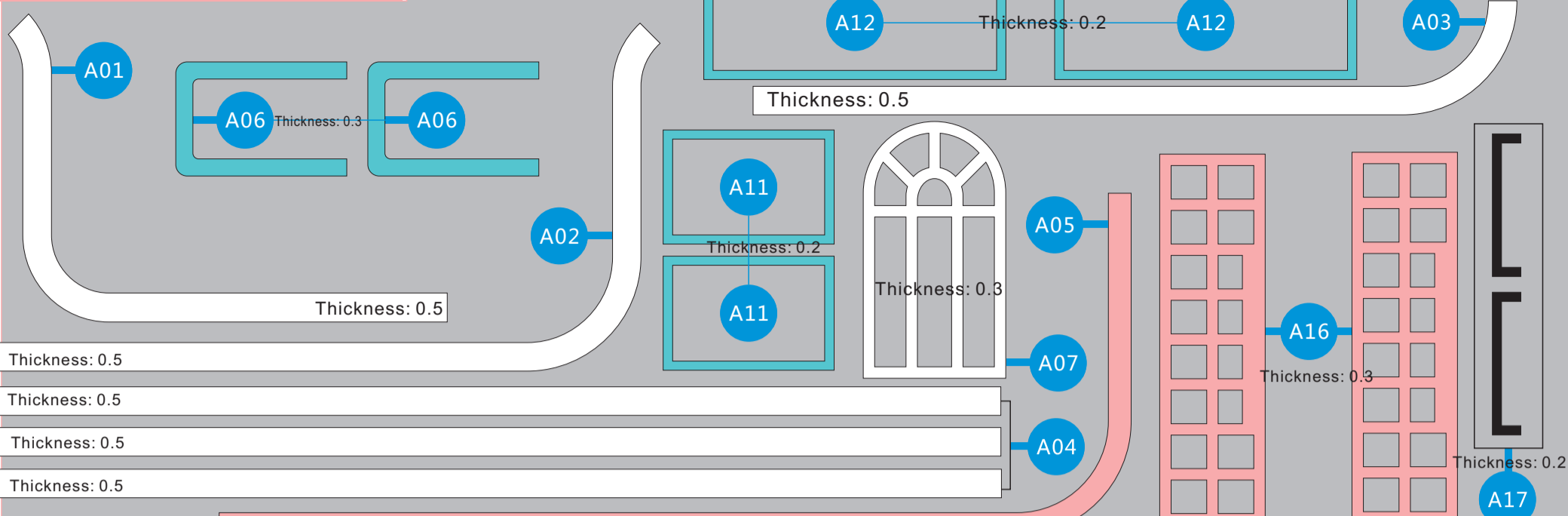

Unit:CM

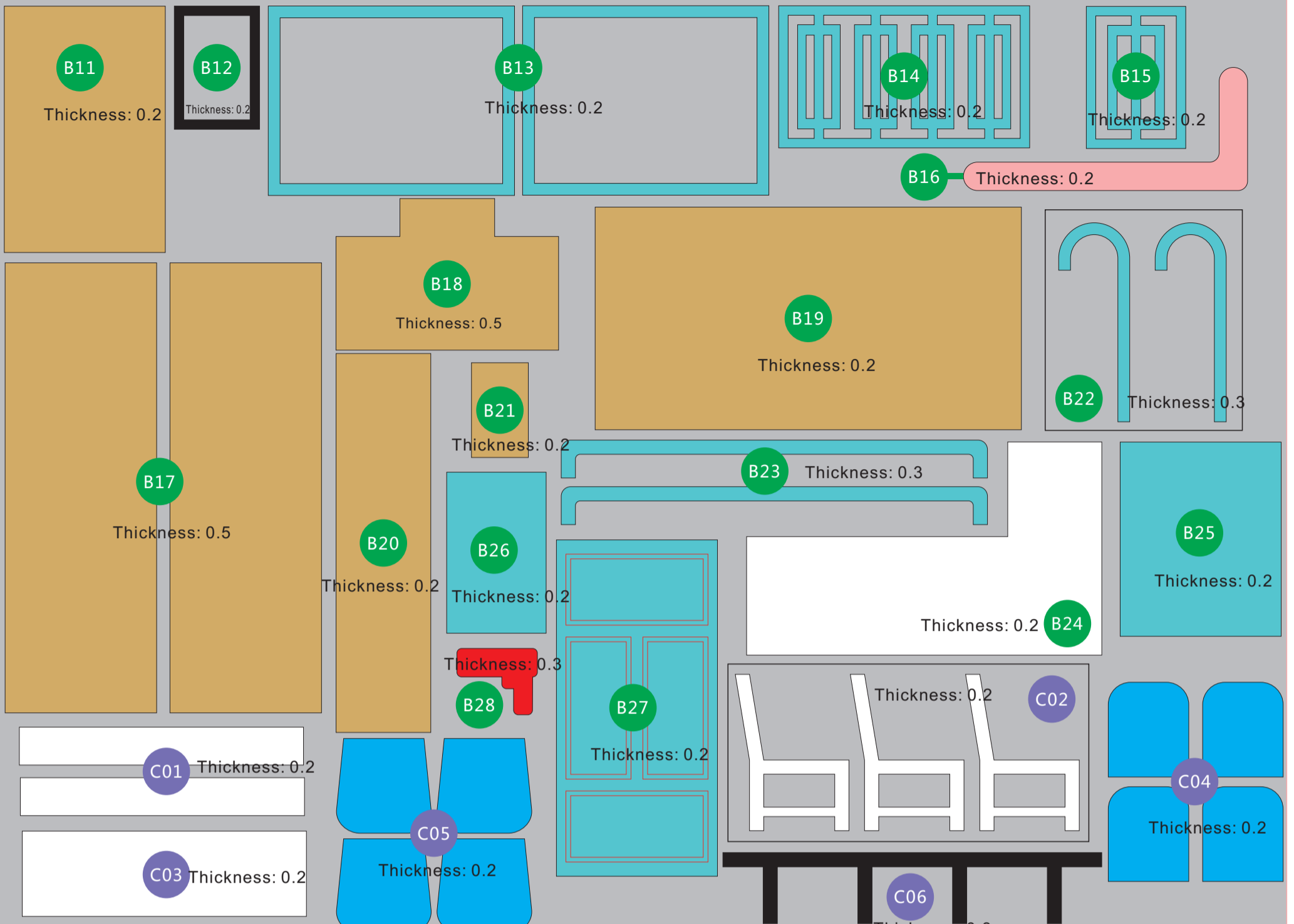

Diameter 0.3

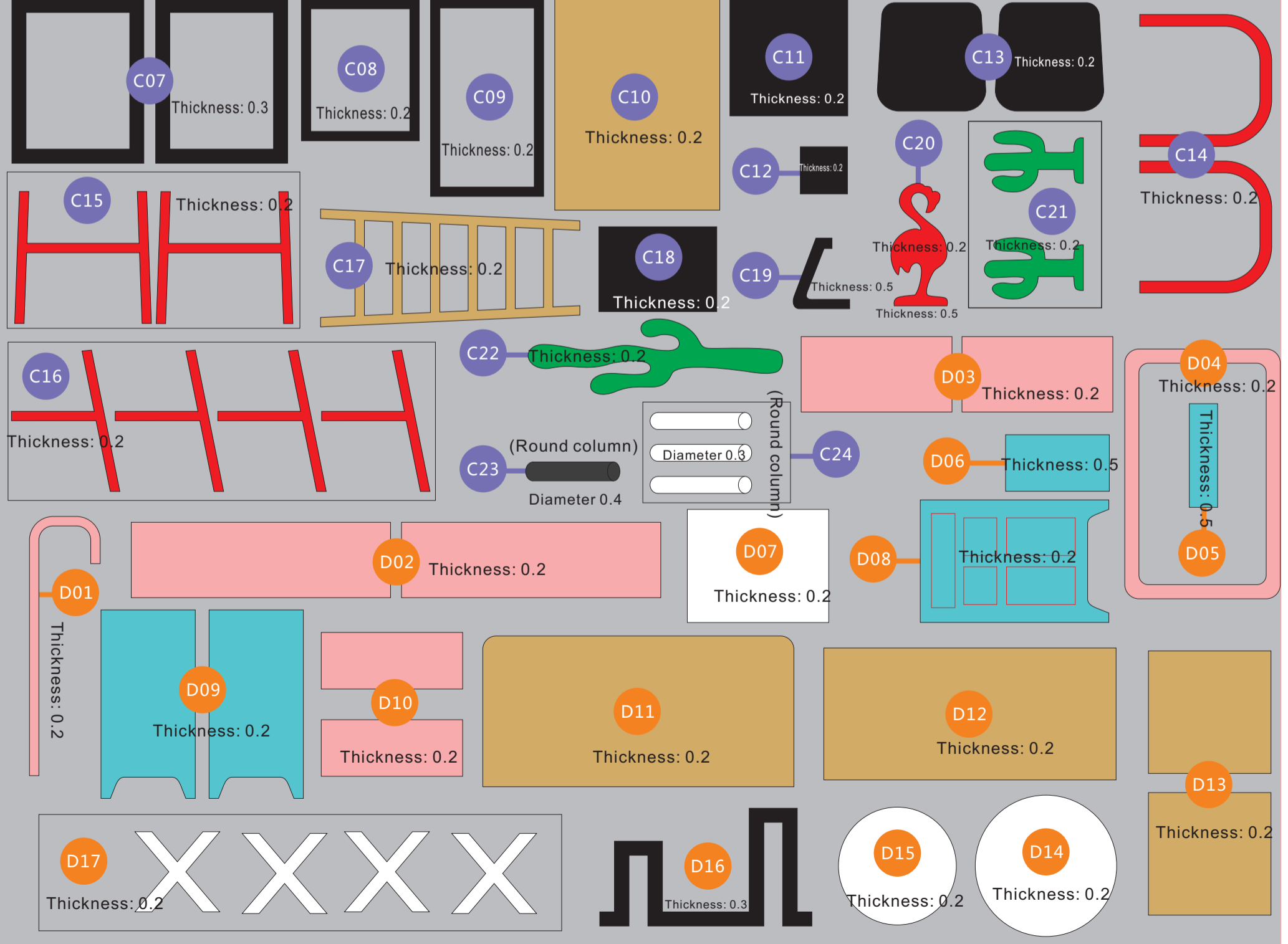

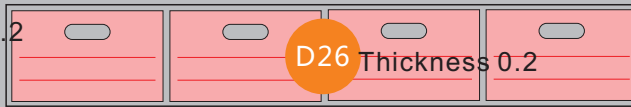
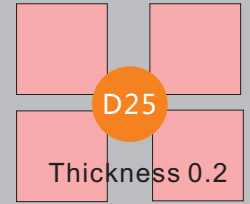
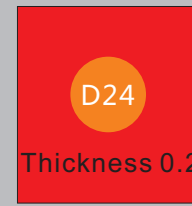

Panel checklist

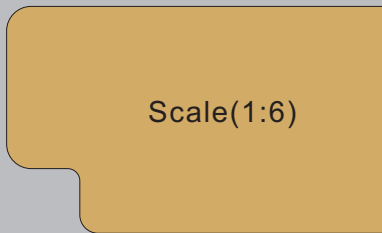

K034-E01  
Panel around by white  
0.5x31x18.6  
(1pc)

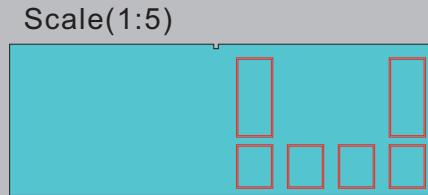

K034-E02  
Panel front blue, back by pink  
0.5x28x10  
(1pc)

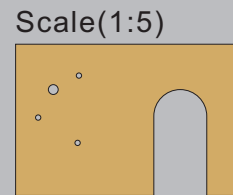

K034-E03  
Panel wood  
0.3x15x10  
(1pc)

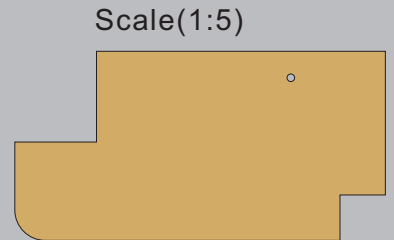

K034-E04  
Panel around by white  
0.5x24.5x12.5  
(1pc)

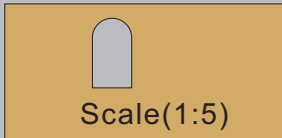

K034-E05  
panel around by white  
0.5x18.5x9  
(1pc)

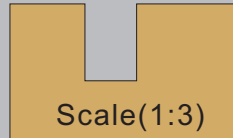

K034-E06  
panel around by white  
0.5x5.4x9  
(1pc)

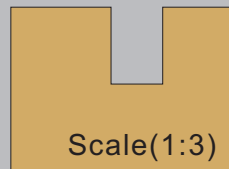

K034-E07  
panel around by white  
0.5x6.5x9  
(1pc)

Dust cover checklist

Note: dust cover is need extra to buy

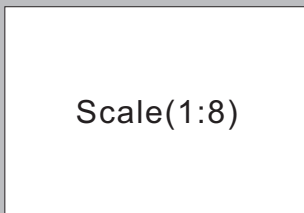

K034-E08  
dust cover panel white  
0.5x32.5x22.5  
(1pc)

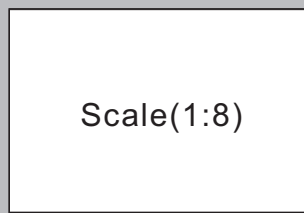

K034-E09  
dust cover Transparent  
0.2x31.5x21.2  
(1pc)

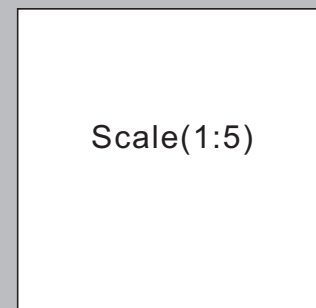

K034-E10  
dust cover transparent  
0.2x21.2x21.2  
(2pcs)

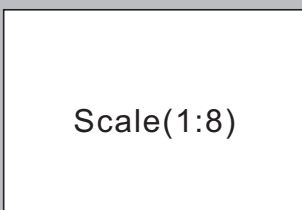

K034-E11  
dust cover transparent  
0.2x31.5x21.5  
(1pcs)



size:42\*28.5/pc

G01 print paper (color) (3pcs)



G02 BIG movement (sliver) (1pc)



(need buy NO.7 battery)  
G03 battery case (black) (1pc)



G04 white glue (white) (1pc)



G05 Sandpaper (brown) (1pc)

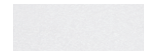

G06 Wood grain paper (white) (1pc)



G07 LED light (white) (5pcs)



G08 light line (white) (1pc)



G09 wire line (green) (1pc)



G10 wire line (Gold) (1pc)



G11 wire line (black) (1pc)



G12 cloth (pink) (1pc)



G13 linen (Beige) (1pc)



G14 Lace edge (white) (1pc)



G15 cotton (white) (some)



G16 no-woven (white) (1pc)



G17 card paper (white) (1pc)

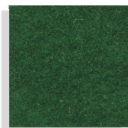

G18 stimulation (green) (1pc)



G19 Simulated flesh (Violet green) (1pc)



G20 stimulation tree (green) (1pc)



G21 stimulation tree (violet green) (2pcs)



G22 dry flower (green) (some)



G23Foam grain (white) (1pc)



G24 Sand (yellow) (some)



G25 Bucket beads (white) (5pcs)



G26 Frosted beads (Transparent) (4pcs)



G27 long bead (white) (1)



G28 Cylindrical beads (white) (1pc)



G29 Water droplets (white) (2pcs)



G30 flat beads (white) (1pc)



G31 small gold beads (gold) (2pcs)



G32 flower beads (gold) (1pc)



G33 flower beads (purple) (2pcs)



G34 Transparent beads (Transparent) (1pc)



G35 Funnel beads (sliver) (1pc)



G36 cup (transparent) (5pcs)



G37 Kiwifruit (green) (2pcs)



G38 watermelon (red) (2pcs)

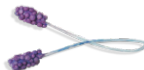

G39 flower (purple) (3pcs)



G40 Diamond beads (transparent) (2pcs)



G41 cat (brown) (1pc)



G42 long beads (green) (4pcs)



G43 short beads (gold) (2pcs)



G44 transparent beads (blue) (2pcs)



Random Color  
G45 color (colorful) (3pcs)



G46 coffee cup (white) (1pc)



G47 Flat buckle (bronze) (3pc)



G48 Flat buckle (bronze) (3pc)



G49 Big corns (bronze) (1pc)



G50 receptacle (gold) (3pcs)



G51 small corns (bronze) (10pc)



G52 wood beads (black) (4pcs)

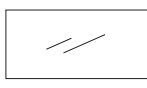

G53 dust cover (transparent) (1pc)